

2017

## FLOODPLAIN MANAGEMENT IN WEST VIRGINIA



# Quick Guide

West Virginia Division of Homeland Security  
and Emergency Management  
Floodplain Management Program  
Bldg. 1, Room EB-80, 1900 Kanawha Blvd., East  
Charleston, WV 25305, 304-957-2571  
<http://www.dhsem.wv.gov/Pages/default.aspx>





View

Layers

Search

Tools

Public

Expert

Risk MAP

Flood

Reference

Basemap

Input your address



A

B

C

D

E

F

G

H

I

J

K

L

M

**A. PUBLIC VIEW:** This default icon serves to make an initial flood hazard determination. Type in your address under SEARCH. Red area is the established floodplain.

**B. EXPERT VIEW.** More advanced view for Floodplain Managers and informed citizens familiar with detailed flood maps.

**C. RISK MAP.** Advanced information for City Planners to help reduce flood risk to property. Information by Census Block only.

**D. FLOOD LAYER.** Reduce red opacity by moving ball on line to see under flood zone.

**E. REFERENCE LAYER.** Use to add addresses, streets, state routes, streams, contour lines.

**F. BASEMAP LAYER.** Variety of background layers to add life like background, topographical layer to view terrain, leaf on/off, infrared.

**G. MEASURING TOOL.** For measuring distances and areas.

**H. MARKUP TOOL.** Use to specifically ID your structure on map, eg, My House.

**I. ERASER TOOL.** Click on to erase any temporary markings.

**J. BOOKMARK TOOL.** Establish bookmark remembered by your computer.

**K. SHARELINK TOOL.** Copy link to share your map with anyone.

**L. PRINT TOOL.** Print and notate PDF

**M. ?.** Additional help tool.

SEE HOME PAGE FOR ADDITIONAL VALUABLE INFORMATION AND INSTRUCTIONS.

## USING THE TOOL

Type [www.mapwv.gov/flood](http://www.mapwv.gov/flood) into your browser

### GETTING STARTED:

Click on Red launch tool icon. Read and sign off on disclaimer. WV map will appear.

Type in your address under SEARCH. Your area will come up with a red pin located at your approximate structure.

You can magnify area by drawing box around red pin after clicking on plus sign at far left under scale navigation bar. Move up/down ball on scale bar at left to +/- magnification. If pin is not directly over your structure, place cursor "hand" over it and click. Informational box will appear. Red area is the floodplain. To see under floodplain, click on D and adjust ball. Click BASEMAP layer, and choose best leaf off background for best real life resolution. Addresses, roads, and contour lines can be added by clicking on the REFERENCE layer.

You can use cursor hand to pan in any direction. Everywhere you left click an informational box will appear.

Informational box will give ground elevation, in/out of floodplain, latitude/longitude, official FIRM map access and contact for your area.

If your area has a detailed FEMA study, you can click on the expert view and compare your structures' ground elevation with a nearby Base Flood Elevation (BFE)

## Purpose

This tool is designed to give an initial estimate of your flood risk quickly, easily and free of charge. The best available digital flood hazard data, elevation data, and aerial photography for West Virginia has been utilized. However, users should always consult official FEMA flood maps and certified elevation data if there is any doubt of a property's flood risk.

The tool may be used to make informed, initial decisions about the degree of flood risk faced and whether precautions should be taken such as purchase of flood insurance, elevation of the structure, flood proofing, etc., by concerned citizens, home owners, lenders, business owners, community planners, floodplain managers, developers, real estate agents, surveyors and engineers.

**REMEMBER:  
IF IN DOUBT, ITS NOT OUT!**

## Table of Contents

- 1..... About this Guide
- 2..... West Virginia Flood Disaster Declarations
- 3..... National Flood Insurance Program
- 4..... Effects of Non-Participation in the NFIP
- 5..... NFIP Community Rating System
- 6..... Why Do We Regulate the Floodplain?
- 7..... Community Responsibilities
- 8..... Introduction to the Riverine Watershed
- 9..... Natural and Beneficial Floodplain Function
- 10... Safe Uses of the Floodplain
- 11... Annual Chance Floods
- 12... Understanding the Riverine Floodplain
- 13... Understanding the Floodway
- 14... Looking for Floodplain Information?
- 15... FEMA Online Flood Map Tools
- 16... West Virginia Flood Hazard Determination Tool
- 17... Evolution of FEMA Flood Maps
- 18... Flood Hazard Boundary Map
- 19... Flood Boundary and Floodway Map
- 20... Old Format Flood Insurance Rate Map
- 21... Newer Format Flood Insurance Rate Map
- 22... The Countywide Digital FIRM
- 23... Use the Stream Flood Profile to Determine BFEs
- 24... Floodway Data Tables
- 25... Approximate Zone A
- 26... Approximate Zone A Procedures
- 27... Nature Doesn't Read Maps!
- 28... Letters of Map Change - LOMAs
- 30... Letters of Map Change - LOMRs
- 31... What is a Basement?
- 32... Basements Are Unsafe in Special Flood Hazard Areas
- 33... Some Activities Requiring Floodplain Development Permits
- 34... Some Key Steps in Floodplain Development Permit Review
- 35... West Virginia Permit Requirements
- 36... Floodplain Development Permit Review in Rural Areas
- 37... Complete the Permit Application
- 38... Permits for Stream Activity
- 39... Think Carefully Before You Seek a Variance
- 40... Floodplain Fill
- 41... Development Can Increase Flooding
- 42... Required Floodway "No Rise/No Impact" Certification
- 43... What is an Elevation Certificate and How is it Used?
- 44... Completing the Elevation Certificate
- 45... Is Your Building Site Higher than the BFE?

## Table of Contents (continued)

- 46... The Lowest Floor
- 47... How to Elevate Your Floodplain Structure
- 48... Elevating an Existing Structure
- 49... Enclosures Below the Lowest Floor
- 50... Crawlspace Details
- 51... Utility Service / Fuel Tanks
- 52... Utility Service Inside Enclosures
- 53... Low Cost Flood Protection for Older Homes
- 54... Berms/Floodwalls Can Protect Pre-FIRM (older) Structures
- 55... Manufactured Homes Deserve Special Attention
- 56... Installation of Manufactured Homes
- 57... Recreational Vehicles
- 58... Accessory Structures
- 59... Private Water Crossings
- 60... Planning to Improve Your Floodplain Building?
- 61... Substantial Improvement: Renovation Only
- 62... Substantial Improvement: Lateral Addition Only
- 63... Substantial Improvement: Addition Plus Other Work
- 64... Non-Substantial Improvements
- 65... What About After Damage?
- 66... Substantial Damage/Improvement Calculations
- 67... Paying for Post Flood Compliance - ICC
- 68... Flood Insurance: Property Owner's Best Protection
- 69... Freeboard: Go Above the BFE
- 70... Flood Insurance in Approximate A Zones
- 71... What is Meant by Pre-FIRM and Post-FIRM?
- 72... Want to Learn More?
- 73... Floodplain Management Success Stories
- 74... Useful Resources
- 75... Selected Definitions

## About this Guide

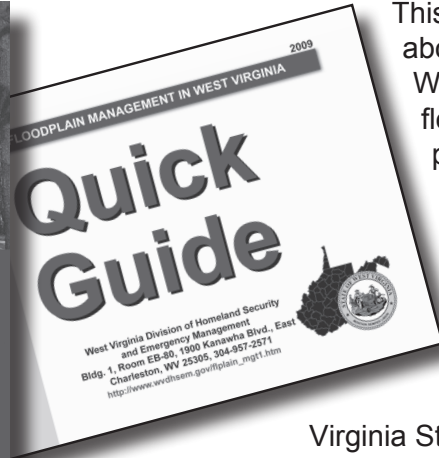
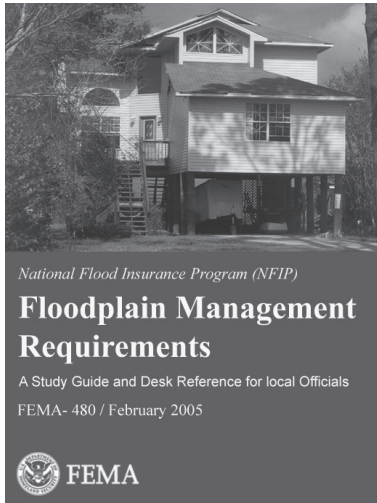

This **Quick Guide** will help you understand more about why and how communities in the State of West Virginia manage floodplains and regulate floodplain development to protect people and property.

Floodprone communities adopt ordinances that detail the rules and requirements for floodplain development. **In case of conflict, that ordinance and not this publication, must be followed.** Please direct questions and comments on this **Quick Guide** to the West

Virginia State Floodplain Management Coordinator at 304-957-2571 or [Kevin L. Sneed@wv.gov](mailto:Kevin.L.Sneed@wv.gov).

For more detail on all aspects of floodplain management, please refer to the Federal Emergency Management Agency (FEMA) *National Flood Insurance Program Floodplain Management Requirements Study Guide and Desk Reference for Local Officials* FEMA Publication 480.

Development of the **Quick Guide** was taxpayer funded through the Federal Emergency Management Agency.



## National Flood Insurance Program

The National Flood Insurance Program (NFIP) was created by Congress in 1968 to protect lives and property and to reduce the financial burden of providing disaster assistance. The NFIP is administered by the Federal Emergency Management Agency. Nationwide, over 21,000 communities participate in the NFIP — including, as of August 2015, all of West Virginia's floodprone communities with effective FEMA flood maps.

The NFIP is based on a mutual agreement between the federal government and communities. Communities that participate agree to regulate floodplain development according to certain criteria and standards.

The partnership involves:

- **Flood Insurance** – Property owners and renters in participating communities are eligible to purchase federal flood insurance for buildings and contents.
- **Flood Hazard Maps** – In partnership with FEMA, various partners produce flood maps in accordance with FEMA standards. The maps are used by communities, insurance agents and others.
- **Regulations** – Communities must adopt and enforce minimum floodplain management regulations so that development, including buildings, is undertaken in ways that reduce exposure to flooding.

To learn more about the NFIP, floodplain management and flood insurance go to: [http://www.wvdhsem.gov/flplain\\_mgt1.htm](http://www.wvdhsem.gov/flplain_mgt1.htm). To learn more about the effects of not participating in the NFIP see the next page.

## Effects of Non-Participation in the NFIP

Communities with Special Flood Hazard Areas (SFHAs) that choose not to participate, that withdraw or have been suspended from the NFIP, may cause undue difficulties for their citizens, especially in the aftermath of a damaging flood event. The following apply to non-participating communities:

**Federal flood insurance is not available.** This also applies to communities without SFHAs that don't participate.

**Federal grants or loans are not available** for any reconstruction, repair, construction, rehabilitation or additions of structures in SFHAs. This includes grants and loans from the Federal Housing Administration, Farmer's Home Administration, Housing and Urban Development, Environmental Protection Agency, Small Business Administration, Veterans Administration and Health and Human Services. Federally backed mortgages are not available for buildings in SFHAs.

**Federal disaster assistance is not provided** for permanent restorative construction of insurable buildings in SFHAs. This means that homes and public buildings damaged by flood are not eligible for federal disaster assistance. Eligible applicants may receive those forms of disaster assistance that are not related to permanent repair and reconstruction of buildings.

**Lenders must notify borrowers.** Lenders may make conventional loans but they must notify the buyer or lessee that their property is in a SFHA, that NFIP flood insurance is not available and that the property in a SFHA is not eligible for Federal disaster relief in a flood-related declared disaster.

**Discounted flood insurance for older buildings is no longer available.** The Flood Insurance Rate Map and appropriate actuarial rates go into effect regardless of whether the community participates. Buildings in SFHAs will be actuarially rated if the community later decides to join the NFIP. This could lead to extremely expensive insurance.

**The local government may be held liable** for not participating in the NFIP because that action denies citizens the opportunity to purchase flood insurance and because it does not take positive steps to reduce the exposure of life and property to danger in the face of authoritative scientific and technical data.



## NFIP Community Rating System

The NFIP's Community Rating System (CRS) is a voluntary program that provides communities the opportunity to reduce flood insurance premiums for its citizens. Communities in the regular phase of the NFIP may apply to participate in the CRS. To participate the community must commit to implement and certify activities that contribute to reduced flood risk. Examples of actions communities can take to reduce the cost of flood insurance premiums include:

- Inform people about floodplain management, flood hazards, flood insurance and flood protection.
- Monitor flood conditions, issue warnings and coordinate flood response activities.
- Preserve open space in the floodplain.
- Enact and enforce higher standards for safer development.
- Maintain the flood carrying and storage capacity of drainage systems.
- Undertake engineering studies and develop floodplain maps and flood data.
- Obtain grants to buy out or elevate houses or to floodproof businesses.

Property owners in 8 West Virginia communities with a "Class 8 or 9" CRS rating receive discounts ranging from 5% to 15% for properties in a Special Flood Hazard Area (SFHA) and 5% for properties not in a SFHA. For detailed information about the CRS program go to <http://training.fema.gov/EMIWeb/CRS/>.

## Why Do We Regulate the Floodplain?

**To protect people and property** – Floodplain management is about reducing vulnerability to flood risk to our built environment. If we know low lying land will flood from time to time, we should make reasonable decisions to help protect our families, homes, and businesses.

**To reduce future flood losses in West Virginia** – Floodplain development regulations are simply a “good neighbor” policy designed to protect our citizens from future flood losses. Regulating floodplain development helps keep flooding conditions from getting worse as development continues.

**To make sure that federal flood insurance is available** – Communities must join the NFIP before its residents can purchase a policy through the program. If not participating, the community can be ineligible for some types of assistance such as State and Federal loans and grants. In addition, residents may be unable to secure a mortgage.

**To save tax dollars** – Every time you hear about a flood disaster, think about what it means to the community’s budget. If we build smart, we’ll have fewer problems the next time the water rises. Remember, federal disaster assistance is not available for all floods. Even when the President declares a disaster, your community could still incur a portion of the repair, cleanup and evacuation costs.

**To avoid liability and lawsuits** – If we know an area is mapped as a floodplain and likely to flood and we know people could be in danger and buildings could be damaged, doesn’t it make sense to take reasonable protective steps as we develop and build?

## Community Responsibilities

To participate in the NFIP, your community agrees to adopt and enforce a flood damage prevention ordinance. Responsibilities required by ordinances include, but may not be limited to:

- **Appoint** a Floodplain Manager and develop a permit system.
- **Require** Elevation Certificates to document compliance.
- **Require** new and substantially improved residential structures and manufactured homes to be elevated to or above the Base Flood Elevation (BFE). (Two feet above BFE is recommended and is required in most communities).
- **Conduct** field inspections and cite any violations to the community's Flood Damage Prevention Ordinance.
- **Require** non-residential structures to be elevated or floodproofed to or above the BFE.
- **Ensure** that building sites are reasonably safe from flooding.
- **Carefully** consider requests for variance.
- **Advise** FEMA when updates to flood maps are needed, except when adopting new area.



## Introduction to the Riverine Watershed

A watershed is the area of land that drains runoff to a point on a waterway. Sometimes it is called the drainage basin. The size and shape of a watershed depends on the shape of the land, the underlying geology, the steepness of the slopes, and how many small waterways, or tributaries, join the larger waterway.

Every river, creek, stream and ditch has a watershed. Many small watersheds, or sub-watersheds, combine to make large watersheds.

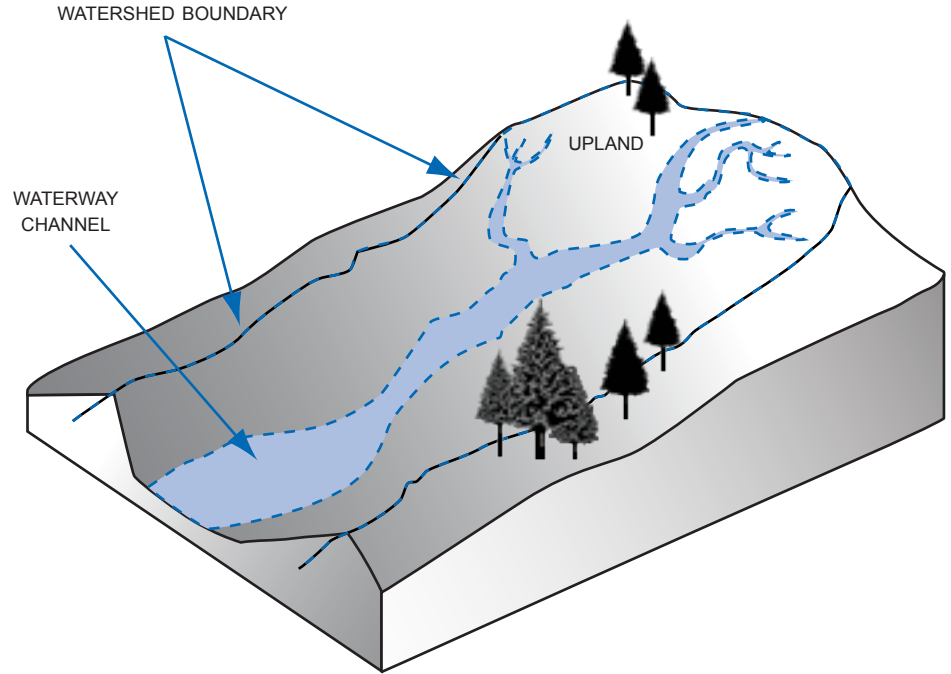

## Natural and Beneficial Floodplain Function

Undeveloped floodplains serve natural and beneficial functions. They can:

- Store flood water and stormwater.
- Enhance water quality by filtering runoff through wetlands.
- Offer habitats for plants and animals.
- Sustain biological productivity.
- Reduce erosion and sediment runoff.
- Offer recreation opportunities.

"No Adverse Impact" (NAI) floodplain management is essentially a "do-no-harm" policy based on the concept that the actions of any community or property owner should not adversely affect others. It calls for identifying the potential direct and indirect adverse impacts of any development action on people, property and the environment. Adverse impacts must be avoided or mitigated.



## Safe Uses of the Floodplain

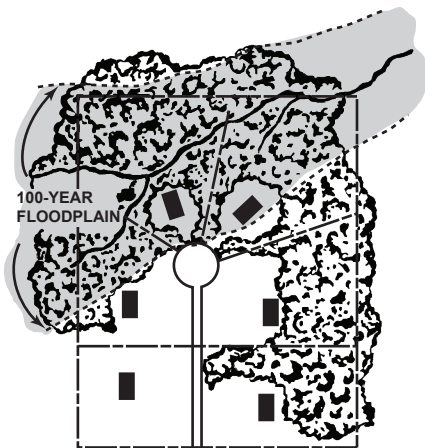

All land subdivided into lots, some home sites and lots partially or entirely in the floodplain.

**NOT RECOMMENDED**

All land subdivided into lots, some lots partially in the floodplain with setbacks to keep home sites on high ground.

**RECOMMENDED**

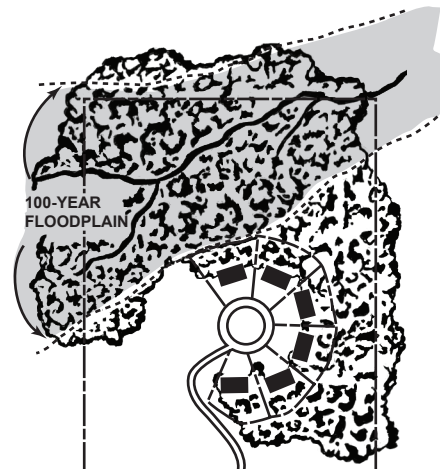
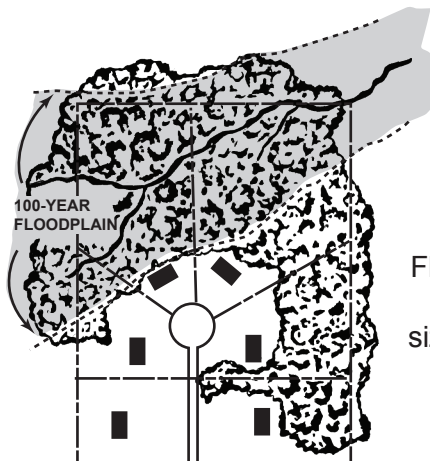

Floodplain land put into public/common open space, net density remains, lot sizes reduced and setbacks modified to keep home sites on high ground.

**RECOMMENDED**

Let the floodplain do its job - if possible, keep it natural open space. Other low damage uses include: recreational areas with no buildings, athletic fields, hiker-biker trails, parking areas with gravel or pervious surfaces, tree farms, nurseries and gardens, pasture and croplands, reforestation, and created wetlands.

## Annual Chance Floods

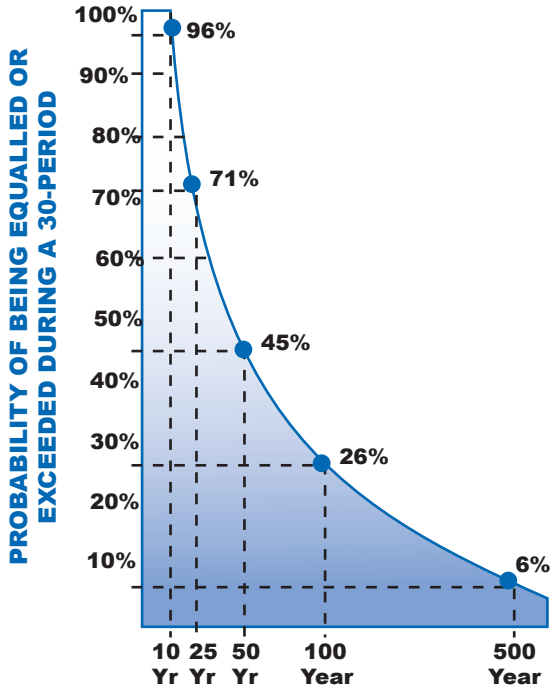

The 1%-annual chance flood, also called the Base Flood and commonly called the 100-year flood, (that does not mean the 100-year flood occurs only once every 100 years) has been selected by the National Flood Insurance Program as the basis for delineation of Special Flood Hazard Areas on Flood Insurance Rate Maps (FIRMs). The Special Flood Hazard Area is the basis for floodplain regulations administered by West Virginia communities.

The boundary of the floodplain delineated for the 0.2%-annual chance flood (also called the 500-year flood) sometimes is shown on the NFIP flood maps.

 **Terms and Definitions**

The **Base Flood** is the 1%-annual chance flood (commonly called the 100-year flood). The 1%-annual chance flood has a 26% or one in 4 chance of occurring during a 30 year period mortgage.

The 0.2%-annual chance flood (or 500-year flood) has a 6% chance of occurring during a 30-year period.

## Understanding the Riverine Floodplain

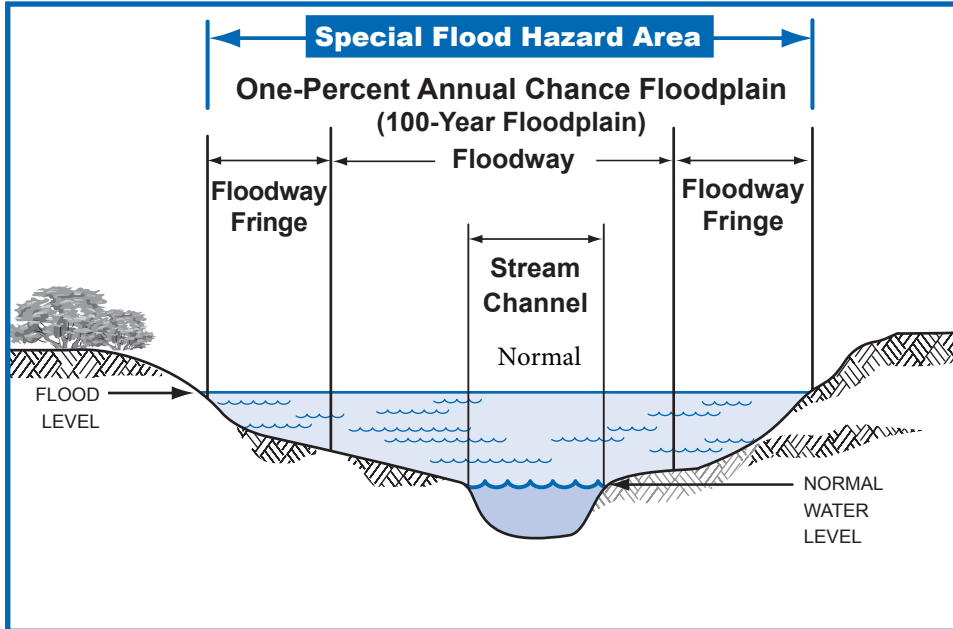

### Terms and Definitions

The **Special Flood Hazard Area (SFHA)** is that portion of the floodplain subject to inundation by the base flood (1%-annual chance) and/or flood-related erosion hazards. SFHAs are shown on FHBMs or FIRMs as Zones A, AE, AH, AO, and AR.

See next page to learn about the floodway, the area of the floodplain where floodwaters usually flow faster and deeper.

For floodplains with Base Flood Elevations (BFEs), check the Flood Insurance Study (FIS) to find the Flood Profile which shows water surface elevations for the different frequency floods (see page 23).



## Understanding the Floodway

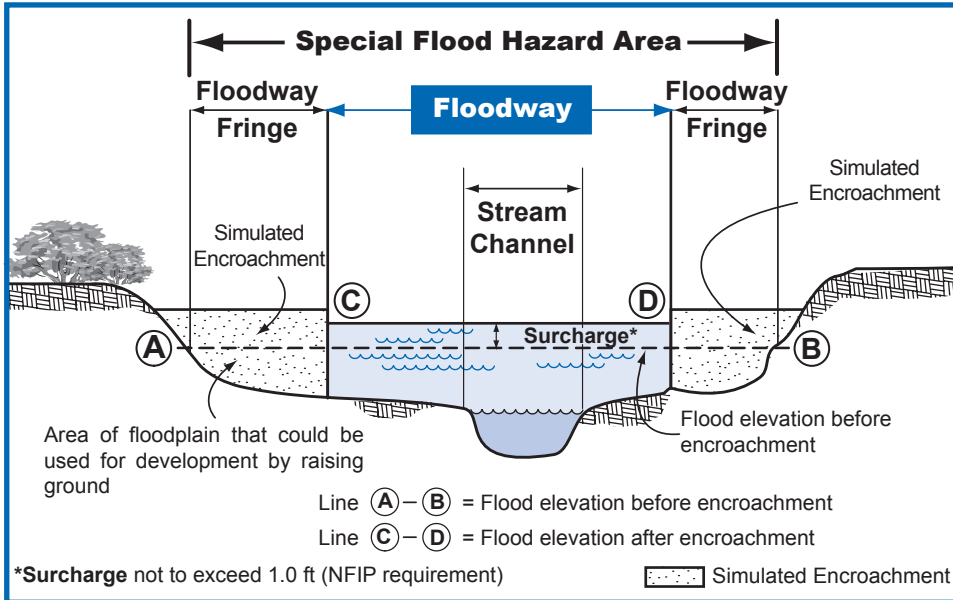

### Terms and Definitions

The **Floodway** is the channel of a river or other water course and the adjacent land areas that must be reserved in order to pass the base flood discharge without cumulatively increasing flood levels by more than one foot.

Computer models of the floodplain are used to simulate “encroachment” or fill in the floodway fringe in order to predict where and how much the Base Flood Elevation (BFE) would increase if the floodplain is allowed to be filled.

Before a local permit can be issued for proposed development in the floodway, a “No Rise/No Impact” certification must be submitted (see page 42). You will need a Professional Engineer licensed in West Virginia, to make sure your proposed project won’t increase flood levels.

## Looking for Floodplain Information?

NATIONAL FLOOD INSURANCE PROGRAM

**FIRM**  
FLOOD INSURANCE RATE MAP

**KANAWHA COUNTY,  
WEST VIRGINIA  
AND UNINCORPORATED AREAS**

**PANEL 428 OF 780**  
(SEE MAP INDEX FOR PANELS LAYOUT)

**CONTAINS:**

COMMUNITY	NUMBER	PANEL	SUFFIX
CHARLESTON CITY OF	540073	0428	E
KANAWHA COUNTY	540070	0428	E

Notice to User: The Map Number shown below should be used when placing map orders; the Community Number shown above should be used on insurance applications for the subject community.

**MAP NUMBER**  
54039C0428E

**EFFECTIVE DATE:**  
FEBRUARY 6, 2008

Federal Emergency Management Agency

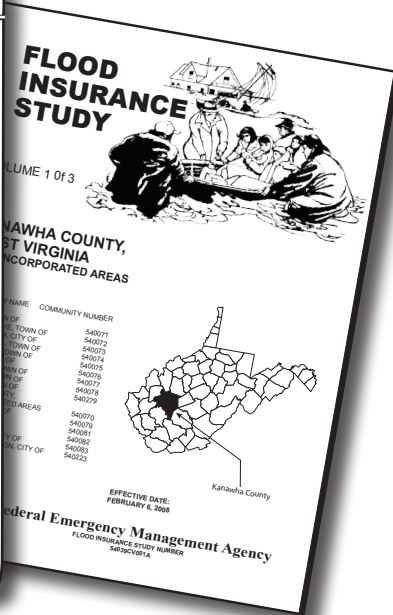

View online flood maps or order paper copies of the flood maps at the FEMA Map Service Center at <http://www.msc.fema.gov/>. You may also order maps by calling 800-358-9616.

FEMA publishes Flood Insurance Rate Maps (FIRMs) and Flood Insurance Studies (FIS) for communities in West Virginia.

All FIRMs show Special Flood Hazard Areas (SFHAs). The flood hazard may be determined by approximate or detailed methods. The Floodway may be modeled as part of the analysis.

Flood hazard studies may be prepared by local governments, state and federal agencies, special districts, or by engineering companies working for private property owners and developers.

To revise the FIRM, studies may be submitted as a Letter of Map Revision (LOMR). FEMA will review the data and revise the FIRMs as appropriate.

Not all waterways have designated floodplains - but all waterways can flood, even though a flood hazard study may not have been prepared.

Flood Maps and Flood Insurance Studies should be available for viewing at your local planning or permit office.

## FEMA Online Flood Map Tools

You can view FIRMs and print clips from FIRMs called FIRMettes by using FEMA's online tools at the FEMA Flood Map Store at: <http://www.msc.fema.gov/>.

From the Map Store you can for free:

- Locate a FIRM by state, county and community and FIRM panel.
- Zoom in or out to view a specific area of a FIRM.
- Create a FIRMette showing a specific area of the FIRM, the FIRM Title Block, north arrow and FIRM approximate scale.
- Print the FIRMette.
- Save the FIRMette as an Adobe PDF or an image file.
- Click on "What is a FIRMette?" on the Flood Map Store web page for detailed instructions on how to make a FIRMette.

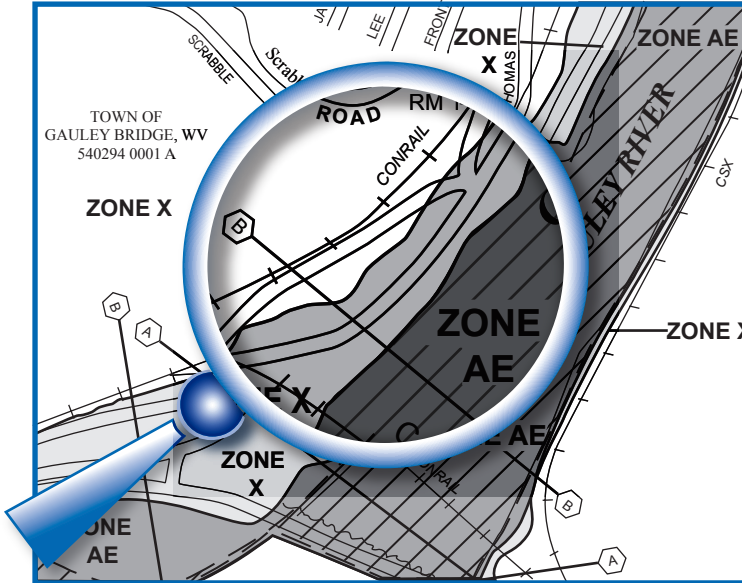

From the Flood Map Store you can purchase paper FIRMs, FIRMs on compact disks and related information. You can also download electronic FIRMs, FIS's and other materials for less cost.

## West Virginia Flood Hazard Determination Tool

This online mapping tool can be used by floodplain managers, insurance and real estate agents, local planners, developers, property owners and others to help make informed decisions about flood risks.

The tool is able to do the following:

- Provide a quick and easy initial determination of flood risk.
- Reduce time and costs associated in making initial determinations.
- Determine if a property is within the SFHA.
- Display corresponding elevation (accurate to +/- 10 vertical feet).
- Link the property location to FEMA's Map Service Center where users can view and/or purchase official flood maps. ([www.msc.fema.gov](http://www.msc.fema.gov))

**Remember: If in doubt, it's not out!**



Digital flood hazard data required by the Flood Hazard Determination Tool is available for all counties under FEMA's Risk Map Program or the Cooperating Technical Partners (CTP) Program. Go to <http://www.mapvw.gov/flood> to take the tutorial and use the tool.

## Evolution of FEMA Flood Maps

Since the inception of the NFIP, FEMA has used several different map formats to depict flood hazards and show flood hazard zone information. Through time map formats have changed replacing previous formats for many communities.

As the maps have changed so have flood zone names and the names of the maps themselves. In some cases delineation of the hazard zones have changed as new studies and other data are incorporated into new maps. In the following pages there are illustrations and information about the types of flood maps still being used in our state. They include: a Flood Hazard Boundary Map (FHBM), a Flood Boundary and Floodway Map (FBFM) commonly called floodway maps, an older format FIRM, a newer format FIRM and the latest format, a County wide Digital FIRM.

Though there are other differences in the various map types most noticeable are changes in flood zone names and the manner in which floodways are displayed, if displayed at all. Briefly:

- Zone A (approximate) are in all map formats though not on every map.
- Zones A 1-30 on the older FIRMS are all Zone AE on the newer FIRMs and DFIRMs.
- Zone B on the older FIRMS is shaded Zone X on the newer FIRMs and DFIRMs.
- Zone C on the older FIRMs is unshaded Zone X on newer FIRMs and DFIRMs.
- Floodways shown as white areas within the boundary of the SFHA on the floodway maps are shown as cross hatched areas on the newer FIRMs and DFIRMs, if they are shown.

The latest effective map for your community is available from the FEMA Map Service Center at <http://www.msc.fema.gov/>

## Flood Hazard Boundary Map

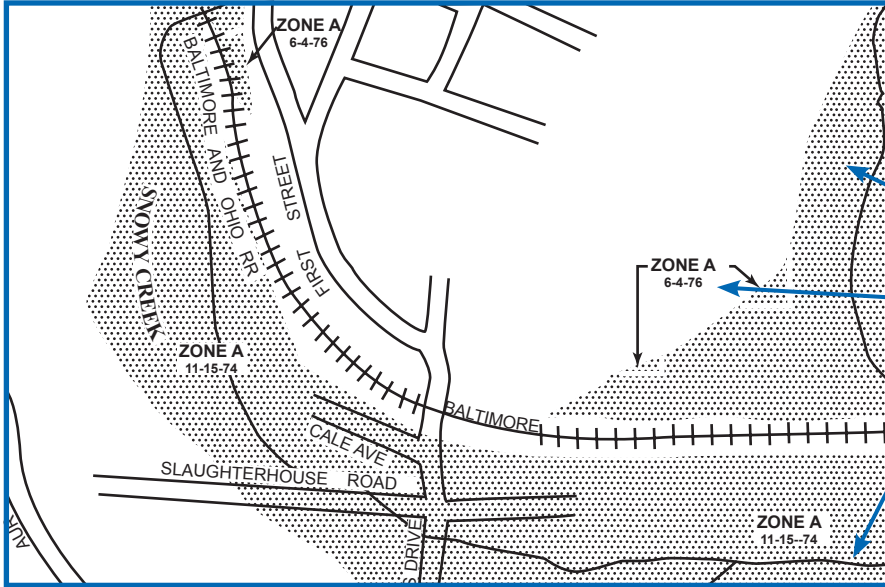

The first generation of flood maps a, Flood Hazard Boundary Map (FHBM) is based on approximate data and identifies, in general, the SFHAs within a community.

**Zone A** is the only flood zone shown and no floodway is depicted.

**Dates of Identification** for varied portions of the A Zone.

**Stream Line** common to all flood maps, the line shows the location of the stream. Single lines represent the center line of small streams, double lines the banks of larger streams.

## Flood Boundary and Floodway Map



Flood Boundary and Floodway Maps are commonly called floodway maps.

**Floodplain Boundaries** are shown but there are no flood zone designations.

**The Floodway** is the white area within the dashed lines of the gray shaded floodplain.

**Cross Section** location, where ground surveys determined the shape of the land and how constrictions such as bridges and culverts affect the flow of floodwater. They correlate to cross section data found in the corresponding FIS.

Floodway maps usually have an accompanying FIRM that shows flood zones and if in a studied area, BFEs and other information. See next page for an excerpt of the area above from the FIRM for this floodway map.

## Old Format Flood Insurance Rate Map

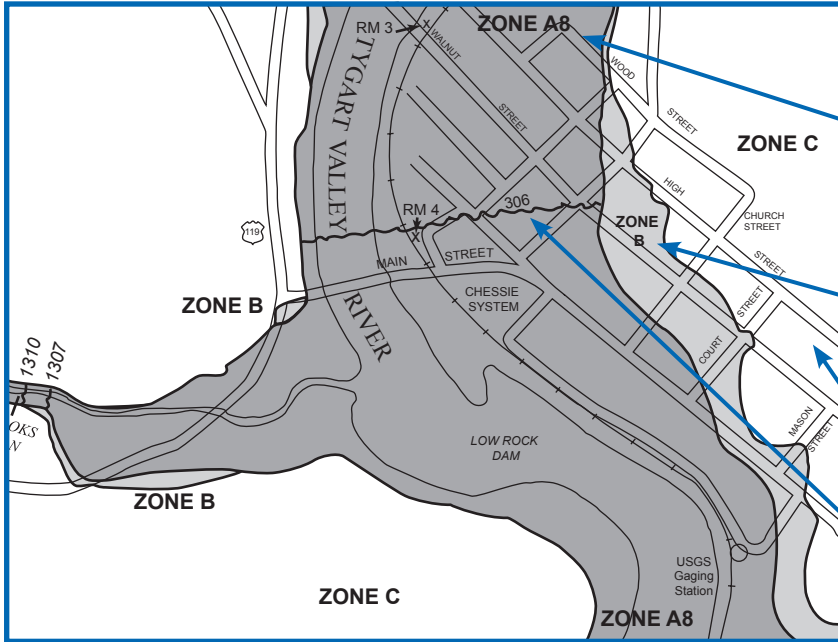

**Zone A** (approximate) is the 1% annual chance floodplain, considered high risk, without BFEs. (Not shown on this map).

**Zones A1-A30** are subject to flooding by the base or 1% annual chance (100-year) flood, and are considered high risk areas.

**Zone B** a moderate risk area, is subject to flooding by the 0.2% annual chance (500-year) flood.

**Zone C** is all other areas, considered to be low risk.

**Base Flood Elevation** is the water surface elevation, rounded to the nearest foot, of the base flood at specific locations.

These maps do not show the floodway distinctly from the entire SFHA. The floodway is shown on the accompanying floodway map. In studied areas BFEs are shown in A1-30 and AH Zones.



## Newer Format Flood Insurance Rate Map

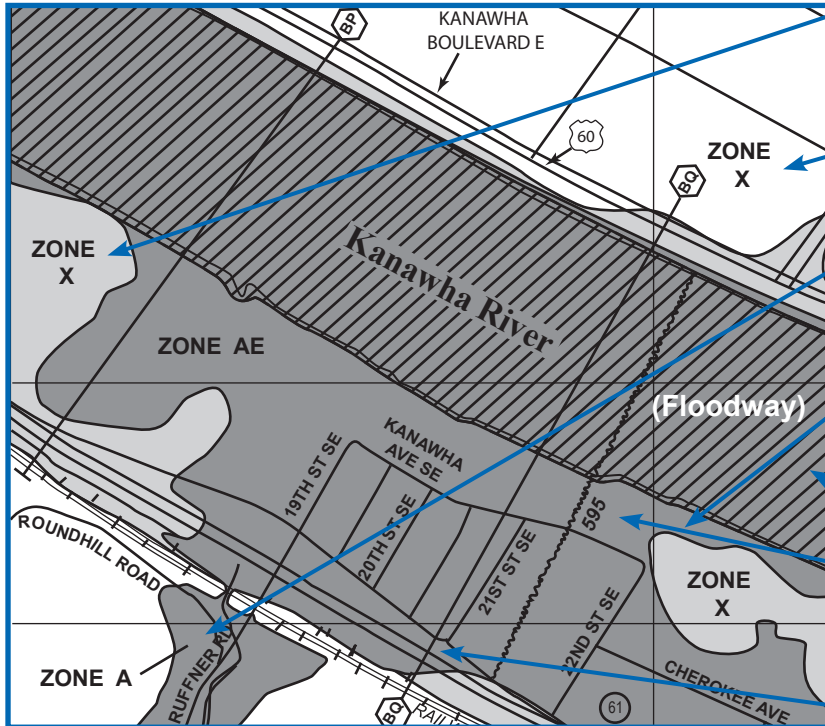

**Zone X** shaded a moderate risk area, is subject to flooding by the 0.2% annual chance (500-year) flood.

**Zone X** unshaded is all other areas considered low risk.

**Zone A** (approximate), a high risk area, is the 1% annual chance floodplain without BFEs.

**Zone AE** a high risk area, is the 1%-annual chance (100-year) floodplain with BFEs.

The **Floodway** is the cross-hatched area.

**Base Flood Elevation** is the water surface elevation, rounded to the nearest foot, of the base flood at specific locations.

**Cross Section** location (see page 19).

## The Countywide Digital FIRM

FEMA, in cooperation with state, local and business partners has produced countywide Digital Flood Insurance Rate Maps (DFIRMs) through the Map Modernization program.

DFIRMs are in an industry-standard Geographic Information System format, that allows users to view information in a graphical format and add or remove layers of data according to their needs.

The flood risk zones, street names jurisdictional boundaries and other data can be overlaid on aerial photographs. The new map format enables more efficient and accurate flood risk determinations.

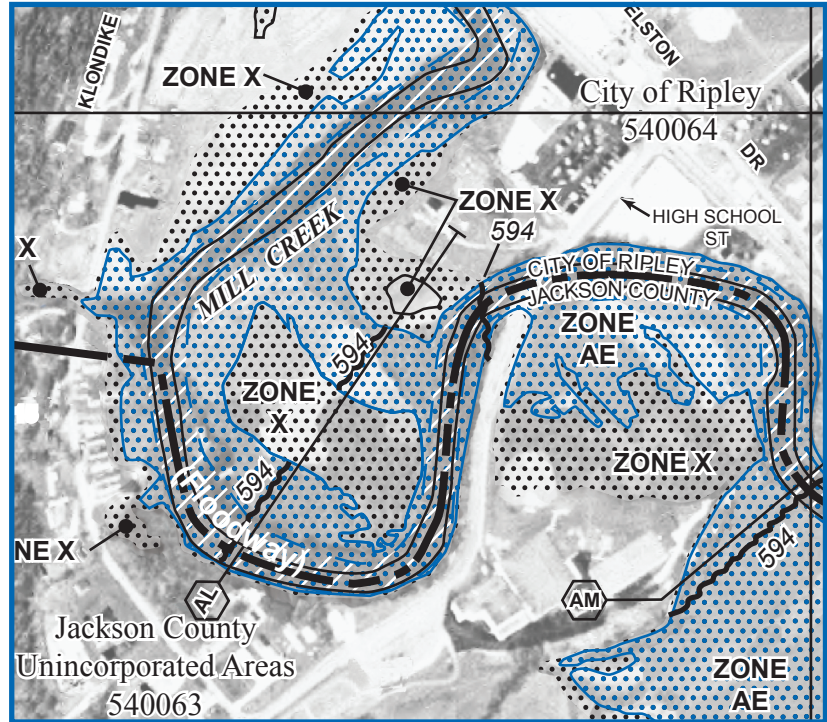

## Use the Stream Flood Profile to Determine BFEs

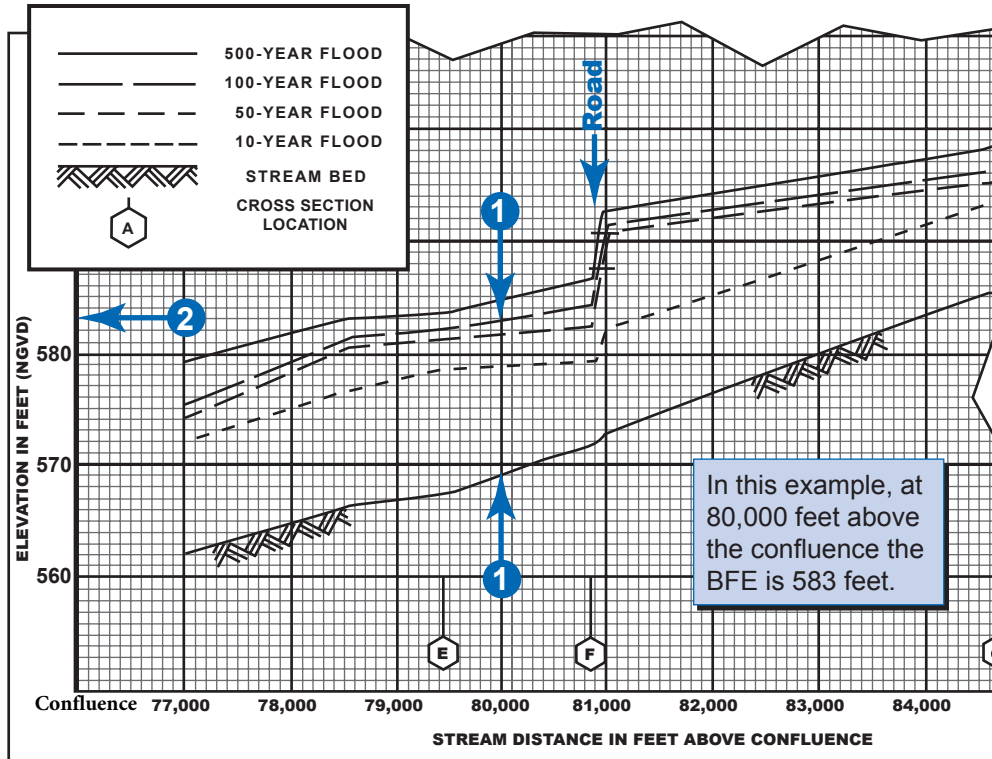

Flood profiles can be used to determine the BFE at a specific site. Profiles also show estimated water surface elevations for floods other than the 1%-percent annual chance flood.

- 1 On the Flood Insurance Rate Map, locate your site by measuring the distance along the centerline of the stream channel from a cross section or bridge, for example,  $\text{E}$  or  $\text{F}$ .
- 2 Scale that distance on the flood profile and read up to the profile of interest, then across to determine the elevation.

## Floodway Data Tables

The Floodway delineates that portion of the SFHA that must be reserved to convey the Base Flood without increasing the water surface elevation more than the amount specified in the Floodway Table.

Floodway			Base Flood Water Surface Elevation			
WIDTH (FEET)	SECTION AREA (SQUARE FEET)	MEAN VELOCITY (FEET PER SECOND)	REGULATORY	WITHOUT FLOODWAY	WITH FLOODWAY	INCREASE
431	4,545	2.6	588.5	588.5	589.5	1.0
422	5,420	2.2	589.1	589.1	590.0	0.9
315	3,674	1.9	591.1	591.1	592.0	0.9
328	4,118	1.6	591.3	591.3	592.2	0.9
272	3,086	2.3	592.2	592.2	593.1	0.9

1

2

3

The Flood Insurance Study (FIS) has a Floodway Table for every waterway that was studied by detailed methods for which floodways were delineated.

- 1 This is the only readily available velocity data to use in computations of hydrodynamic loads.
- 2 Computed BFE (rounded values are shown on the FIRM).
- 3 Amount of allowable increase - not more than 1-foot at any location.

## Approximate Zone A

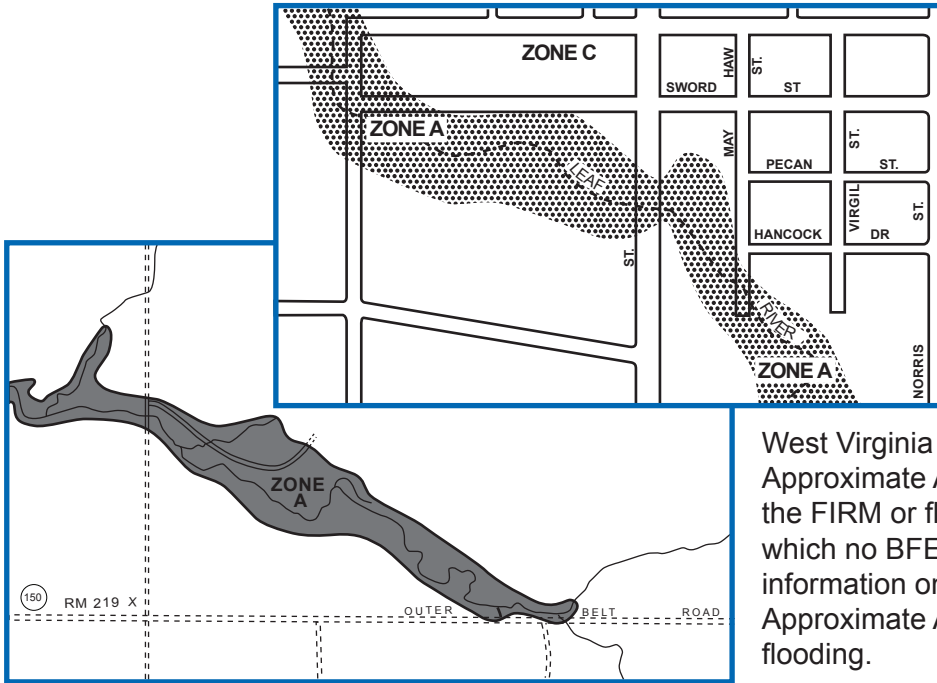

Approximate A zones are drawn based on existing information, not engineering studies. FEMA checked with the U. S. Army Corps of Engineers, the U. S. Geological Survey, the State, local offices, and historic records. When existing information was lacking, an approximate delineation was performed.

West Virginia local floodplain ordinances identify Approximate A zones as those A zone areas on the FIRM or floodway map included in the FIS for which no BFEs are provided. See next page for information on determining if structures sited within Approximate A Zones will be reasonably safe from flooding.

## Approximate Zone A Procedures

FEMA Minimum requirements for floodplain management in Approximate A Zones require communities to determine whether a proposed building site will be "reasonably safe from flooding".

Within Approximate A Zones, communities must "reasonably utilize" any existing flood study produced by an authoritative source such as another governmental agency. The State Coordinators can help determine whether a flood study exists for a particular stream and provide contact information for the appropriate agency.

Many times flood studies from other sources don't exist. This leaves the task of establishing "reasonably safe from flooding" to the local Floodplain Manager.

The West Virginia Floodplain Management Program recommends West Virginia Counties and Municipalities managing Approximate A zones adopt administrative procedures for reviewing site specific risk and establishing a "minimal, moderate or significant" investment level. Jurisdictions can modify the sample procedures for that purpose. Contact the West Virginia State Floodplain Management Program Coordinators at 304-957-2571 or [Kevin L. Sneed@wv.gov](mailto:Kevin.L.Sneed@wv.gov) for a sample procedure.

Methodologies used to determine if a property is "reasonably safe from flooding" range from, but are not limited to, using the West Virginia Flood Hazard Determination Tool (see page 16) for obtaining free elevation data for a garage or shed, to using the United States Geological Survey method for moderate cost projects. More costly development projects may require a full flood insurance study using the United States Army Corps of Engineers Hydrologic Engineering Centers River Analysis System (HEC-RAS) methodology. The West Virginia State Floodplain Management Program Coordinators can help in deciding which methodology is best for any situation.

Building higher based on accurate flood data will ensure long-term flood insurance savings (see pages 69 and 70).

## Nature Doesn't Read Maps!

**Caution!** Nature doesn't read maps! Major storms and flash floods (a WV speciality) can cause flooding that rises higher than the BFE. Consider Safety - protect homes and businesses by building higher. See page 69 to see how this will save money on flood insurance.

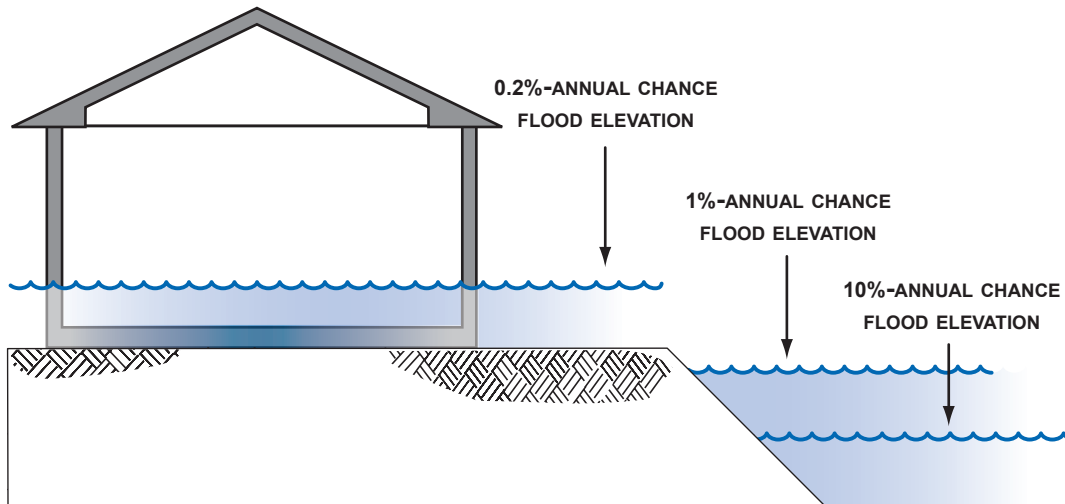

**Important**

### Information

Many people don't understand just how risky the floodplain can be. There is a greater than 1 in 4 chance (26%) that a home in the SFHA will flood during a 30-year mortgage period. The chance that a major fire will occur during the same period is only 6%!

If your property is in a .02% floodplain (500-year) or near a small stream without FEMA mapped flood zones, you are strongly urged to consider buying a Preferred Risk flood insurance policy. The policy starts at around \$146 a year.

A typical **Letter of Map Amendment (LOMA)** can be used in floodplain management but is more commonly used to establish whether a structure with federally backed mortgage will be required to carry flood insurance.

**1** A typical LOMA requires the following:

- Page 1 of FEMA's MT-EZ Application Form for Single Residential Lots or Structure Amendments to NFIP Maps.
- Elevation data showing Lowest Adjacent Grade (LAG) and BFE (if in a studied floodplain) using the current Elevation Certificate or the elevation data on page two of the MT-EZ.
- A FIRMette (see page 15) marked with a X showing the house location.
- A copy of the deed and the tax map also showing the house location.

**2** LOMAs in an Approximate A zone:

- Require all of the above however, the elevation data will not include the BFE. Instead get a surveyor licensed to practice in West Virginia to provide at least one cross section (2 is better) adjacent to the structure.
- If a bridge or culvert is located near the house the surveyor should also provide geometric details of the stream crossing.



### 3 LOMA – Out as Shown

This LOMA can be used for flood insurance purposes but can also be utilized to get FEMA to assign an approximate BFE in a approximate A zone. Follow typical LOMA process but instead of having a surveyor provide the elevation data substitute one of the following:

If structure is well above the floodplain boundary, at least two topographic contour intervals above, try using free data:

- Use the WV Flood Hazard Determination Tool (see page 16) to find the structure and put a star on the structure. The tutorial shows how to do this and other tasks below.
- Print an aerial photo with the topographic contours and floodplain overlay and a USGS topographic map with the star still on the structure.

Or:

If structure is close to floodplain boundary have surveyor produce a plat map showing the footprint of structure and the floodplain boundary.

In any LOMA, if the LAG is below the Base Flood Elevation then the structure will be **in** the floodplain. In the Out As Shown example if the floodplain boundary even touches the structure footprint then the structure will be **in** the floodplain.

- 1 Letter of Map Revision (LOMR)** is an official change to an effective FIRM that may be issued to change flood insurance risk zones, floodplain and boundary delineations, BFEs, and/or other map features. Lenders may waive the flood insurance requirement if the approved map revision shows structures to be outside of the SFHA.
- 2 Letter of Map Revision Based on Fill (LOMR-F)** is an official change to an effective FIRM that is issued to document FEMA's determination that a structure or parcel of land has been elevated by fill above BFE, and therefore is no longer in the SFHA. Lenders may waive the flood insurance requirement if the LOMR-F shows a structure on fill is above the BFE and outside of the SFHA.
- 3 Physical Map Revision (LOMR-PMR)** may be issued for major physical floodplain changes that require engineering analyses, such as bridges, culverts, channel changes, flood control measures, and large fills that change the BFE or Floodway. PMRs are also issued when a new study updates or improves the FIRM.



**Important**

### Information

Check FEMA's Flood Hazard Mapping website for more information about map revisions concerning homeowners, engineers, and surveyors.

To learn the Status of Map Change Requests, call FEMA's Map Service Center at 800-358-9616.

Information:  
<http://www.fema.gov/hazard/map/lomc>

Forms:  
<http://www.fema.gov/business/nfip/forms>

Requests for map revisions must be endorsed by your community.

## What is a Basement?

A **basement** is any portion of a structure that has a subgrade floor (below ground level) on all sides. "Walkout basements," "daylight basements" or "terrace levels" are usually subgrade on only three sides, with one side at or above grade. If the ground slopes toward the floor as in the center illustration, it is considered below ground level and the subgrade floor is a basement.

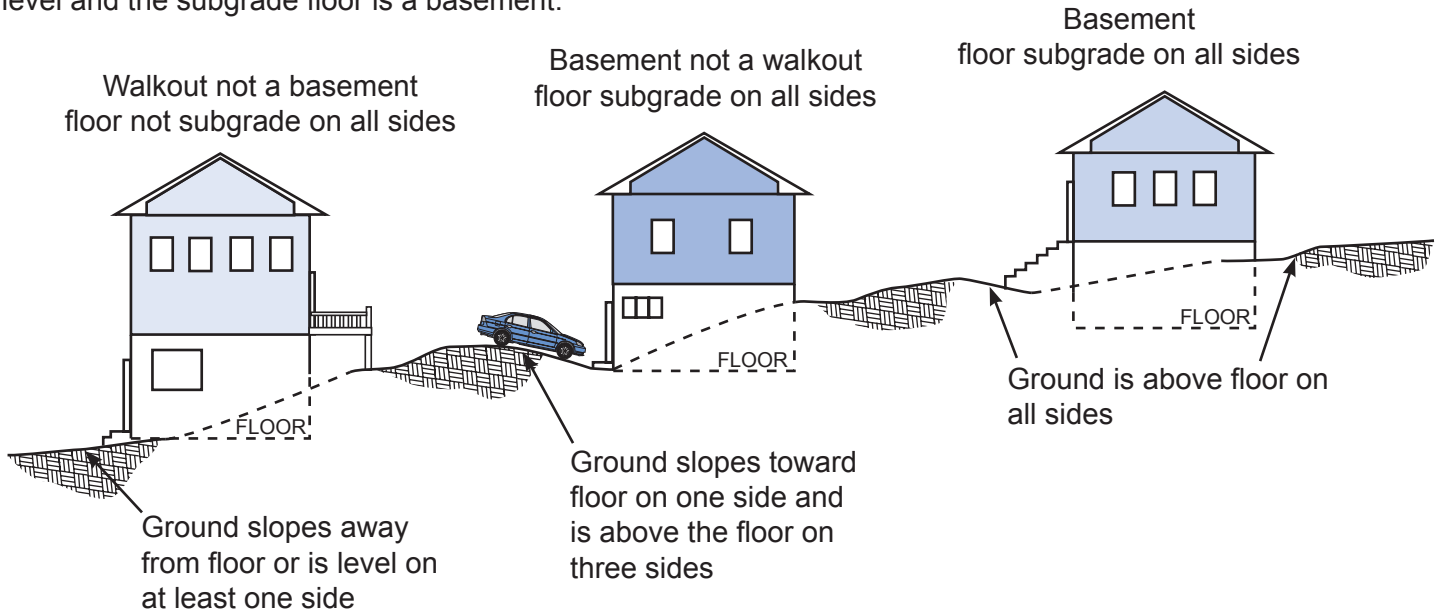

## Basements Are Unsafe in Special Flood Hazard Areas

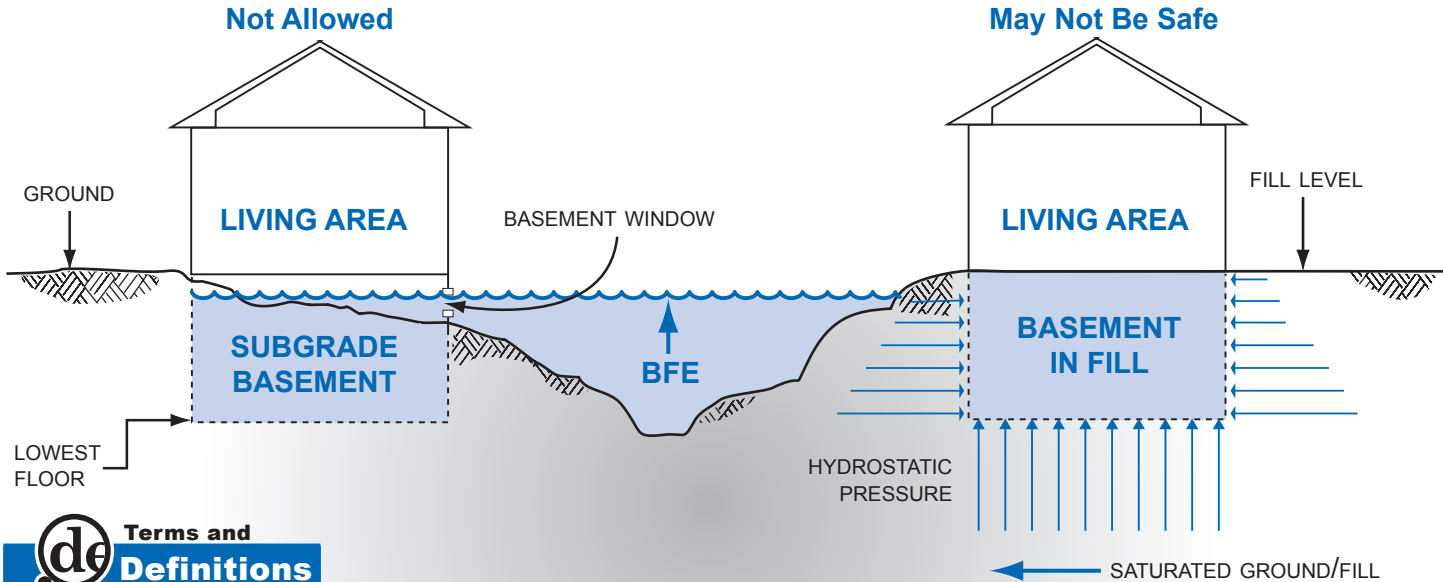

**de** **Terms and Definitions**

A **basement** is any portion of a structure that has a subgrade floor (below ground level) on all sides.

Basements below BFE are **not** allowed in new development and flood insurance coverage is very limited in existing basements for very good reason. It only takes an inch of water over the sill and the entire basement fills up! Excavating a basement into fill doesn't always make it safe because saturated groundwater can damage the walls.

## Activities In SFHA Requiring Floodplain Development Permits

- New construction
- Additions to existing structures
- Substantially improved structures
- Placing manufactured (mobile) homes
- Subdivision development, including infrastructure
- Temporary buildings and accessory structures
- Agricultural buildings
- Parking or storage of recreational vehicles
- Temporary or permanent materials storage, including gas/liquid storage and sand/gravel
- Roads, bridges, and culverts
- Fill, grading, excavation, mining, and dredging
- Stream alteration or relocation



**Permits are required for all of these activities.**

## Some Key Steps in Floodplain Development Permit Review

The Permit Reviewer has to check many things. Key Questions are:

- Is the site in an identified floodplain?
- Is the site in the designated floodway?
- Have all state and federal permits been obtained?
- Is the site "reasonably safe from flooding"?
- Does the site plan show the Base Flood Elevation?
- Does the site plan show existing ground contours?
- Is substantial improvement of an older building being proposed?
- Is an addition proposed?
- Will new structures and utilities be properly elevated and anchored?
- Will the manufactured home be properly elevated and anchored?
- Do the plans show an appropriate and safe foundation?
- Has the owner submitted an Elevation Certificate?



Go to [http://www.wvdhsem.gov/flplain\\_mgt1.htm](http://www.wvdhsem.gov/flplain_mgt1.htm) to download sample West Virginia plan review checklists useful in permit reviews.

## West Virginia Permit Requirements

West Virginia State Code 11-3-3A requires the County Assessor to obtain information on the improvement of real property within all county jurisdictions. According to the law, this must be accomplished through:

- 1 A Location Improvement Permit or,
- 2 A Floodplain Development Permit (for counties and municipalities with adopted Floodplain Ordinances but no building code) or,
- 3 A Building Permit (for counties and municipalities with adopted building codes—the building permit also serves as the Floodplain Development Permit).

All counties and municipalities participating in the NFIP, have a Floodplain Ordinance in effect requiring a Floodplain Development Permit. By state law, when a separate permit system, such as the Floodplain Development Permit, is in place, that permit must be provided to the Assessor as the replacement for the Assessor's Location Improvement Permit, to satisfy the Assessor notification requirement.

The Floodplain Development Permit is also used to help protect water supply and sanitary sewage disposal by providing a copy of any Floodplain Development Permit for new construction and substantial additions to the County Sanitarian. In many counties the floodplain development permit is also provided to County E-911 to help assure addresses are obtained for new construction in order to maintain emergency response dispatch systems.

## Floodplain Development Permit Review in Rural Areas

The Floodplain Development permit review process in rural West Virginia counties and municipalities without adopted building codes should resemble the following:

If the parcel is completely out of the floodplain, the community issues a permit and a Certificate of Compliance marked "not in 100 year floodplain".

When some or all of the parcel is in the floodplain:

On hilly sites with development significantly above the floodplain, a simple site plan or sketch showing the vertical relationship between the floodplain and the development and the distance between the development and a recognized landmark is adequate. The community issues a permit and, after foundation has been placed outside of floodplain as shown on the site plan, a Certificate of Compliance marked "not in 100 year floodplain".

Detailed site plans are required for development in or very near the floodplain. They must show roads and streams, exact location of proposed structure(s), the LAG next to the proposed structure's foundation, the BFE and the location of floodway boundary. When fill is planned, add the location of the "real" floodplain boundary using spot elevations across the parcel.

- If the site plan shows all development will occur on natural grade above BFE, the community issues a permit. When construction progresses enough to confirm the development will not encroach the floodplain, the community issues a Certificate of Compliance marked "not in 100 year floodplain".
- If the site plan shows any part or all of development will occur in the floodplain, the community reviews the proposed development to ensure Floodplain Ordinance compliance, then issues a permit with conditions of compliance.

When development is complete, the developer must provide a finished construction Elevation Certificate for each structure and the community must ensure that fill is placed as proposed. After any required engineering and, copies of permits from any other government regulatory agency are provided, the community issues a Certificate of Compliance or Occupancy.



# Complete the Permit Application

(excerpts)

**\*ASTERICKS INDICATE REQUIRED INFO**

**(COMMUNITY) DEVELOPMENT PERMIT APPLICATION**

\*Permit Number: \_\_\_\_\_ \*Application Date: \_\_\_\_\_

---

**\*SITE INFORMATION**  
 \*Attach Preliminary Site Plan (See Sample)

\*911 address obtained. (permit cannot be processed without 911 address)

SITE ADDR \_\_\_\_\_ *Number [Rt/Box or House]*

SUBDIVISION NAME OR MANUFACTURED HOME PARK \_\_\_\_\_

TAX MAP # \_\_\_\_\_ PARCEL # \_\_\_\_\_

PRIMARY/COUNTY ROAD ACCESS: \_\_\_\_\_

DIRECTIONS TO SITE: \_\_\_\_\_

---

**TYPE OF DEVELOPMENT:**

Check and complete all that apply:

**RESIDENTIAL**

- Single Fa
- Manufac
- Single Fa
- Multi-fan

**ADDITION FOR RESIDENT**

Room(s)  Porch  At

---

**TO BE COMPLETED BY BUILDING PERMIT OFFICE**

Zoning District \_\_\_\_\_ Tax Map \_\_\_\_\_ Parcel \_\_\_\_\_

\*FEMA Panel \_\_\_\_\_ \*Flood Zone \_\_\_\_\_ \*Floodway \_\_\_\_\_

(excerpts)

Site Plan Example

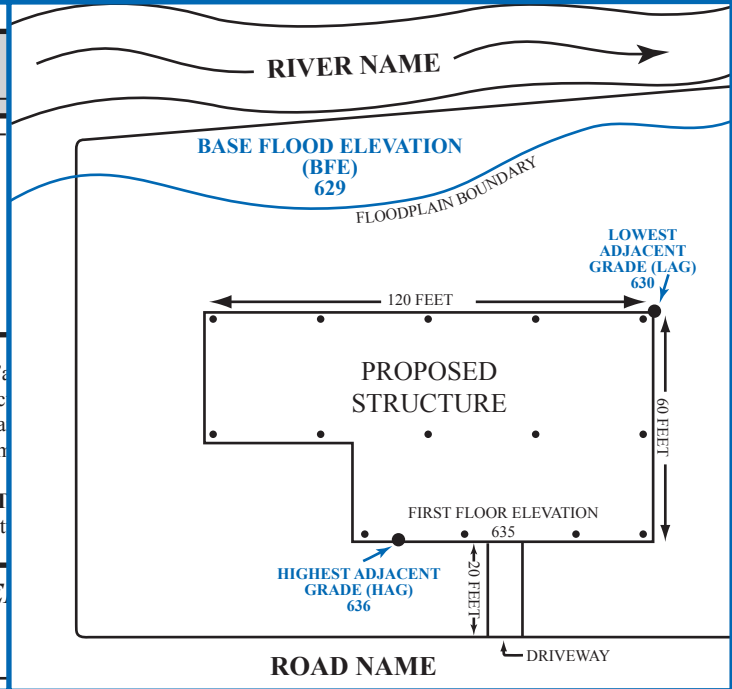

You must get all permits **before** you do work in a floodplain. Contact the West Virginia State Floodplain Management Coordinator at: [Kevin L. Sneed@wv.gov](mailto:Kevin.L.Sneed@wv.gov) to obtain a sample permit application and site plan.

## Permits for Stream Activity

Construction in or across a stream requires authorization from the West Virginia Division of Natural Resources Public Land Office of Land and Streams. Go to <http://www.wvdnr.gov/REM/PLC.shtm> to download a copy of the Stream Activity application.

Activities that involve work in a stream or a wetland (bank stabilization, filling, dredging, or channel relocation) must have a "401 Water Quality Certification" from the United States Army Corps of Engineers.

The West Virginia Stream Access Permitting Program for Landowners, assists individuals by coordinating stream access permitting activities with the U.S. Army Corps of Engineers and by providing follow up technical assistance. The program helps landowners follow an approved stream plan to remove debris and deposits from established stream channels and manage streambank erosion. For a copy of the Stream Access Permitting Program brochure go to <http://www.wv.gov/environment/Pages/default.aspx>

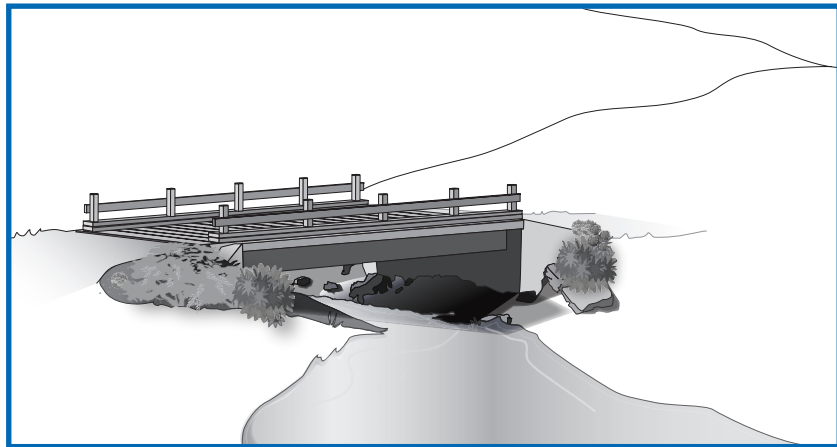

Floodplain activities that must have a local permit include construction of buildings, placement of fill, stream alterations, bridges, culverts, and dams. See page 59 for information about private water crossings.

## Think Carefully Before You Seek a Variance

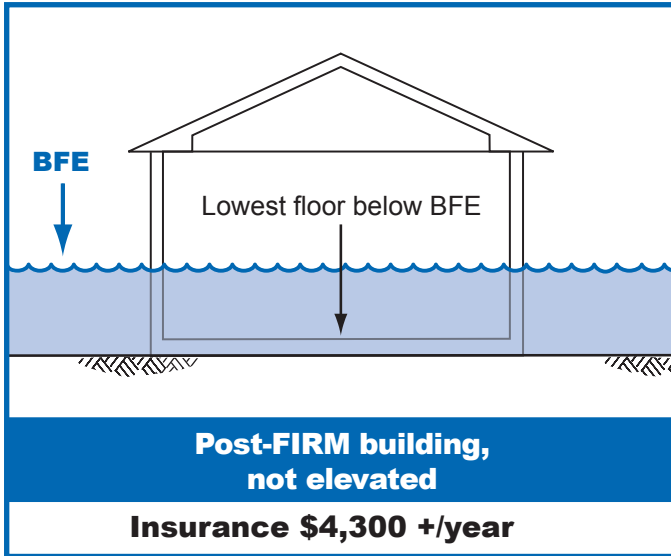

**Very specific conditions** must be satisfied to justify a variance:

- If in a floodway, the project causes no increase in flood level.
- Shall not cause additional threats to public safety or extraordinary public expense.
- Historic structures must meet specific historic structure designation requirements.
- Variances generally may be considered only for accessory (see page 58) and agricultural structures.

Review the variance provisions of your community flood damage prevention ordinance for specific guidance.

A variance that allows construction below the BFE does not waive your lender's flood insurance requirement. **Flood insurance will be very expensive** - perhaps more than \$4,300 per year (see page 69).

Review carefully before issuing a variance to build below the BFE. Not only will the property be more likely to get damaged, but insurance will be very costly. **If your community has a pattern of granting variances inconsistent with the local ordinance, FEMA can impose sanctions - costing even more!**

## Floodplain Fill

Earthen fill used to raise the ground above the flood elevation must be placed properly so that it does not erode or slump when water rises. For safety and to meet floodplain requirements, floodplain fill should:

- Have no adverse impact on adjacent properties or the capacity of channels, floodways or any other drainage system.
- Be contoured to drain properly and extend beyond the structure enough to provide acceptable access.
- Be good clean soil or rock material free of trash and woody material.
- Be compacted to provide necessary stability and resistance to erosion, scouring or settling.
- Have graded side slopes not steeper than 2:1, (flatter slopes are recommended). If steeper than 2 to 1 engineering analysis is required.
- Fill slopes exposed to flood waters during a base flood must be protected from erosion by vegetation or stone armor depending upon anticipated water velocity.

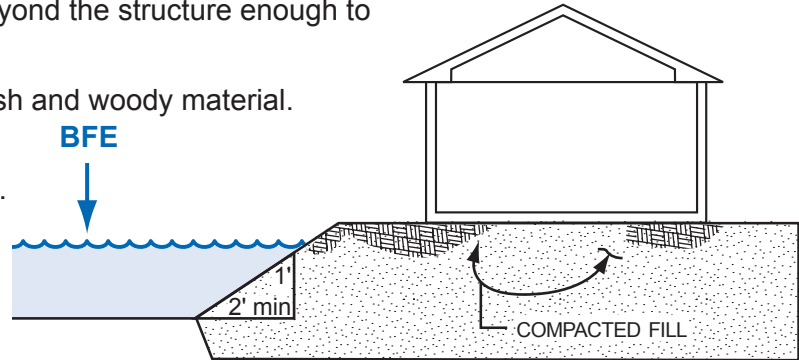

In some communities, fill placement in a SFHA requires obtaining CLOMR-F from FEMA. Upon completing the fill, the CLOMR-F must be converted to a LOMR-F before a certificate of compliance will be issued.

## Development Can Increase Flooding

### FLOODPLAIN AFTER FILLING OR WATERSHED DEVELOPMENT

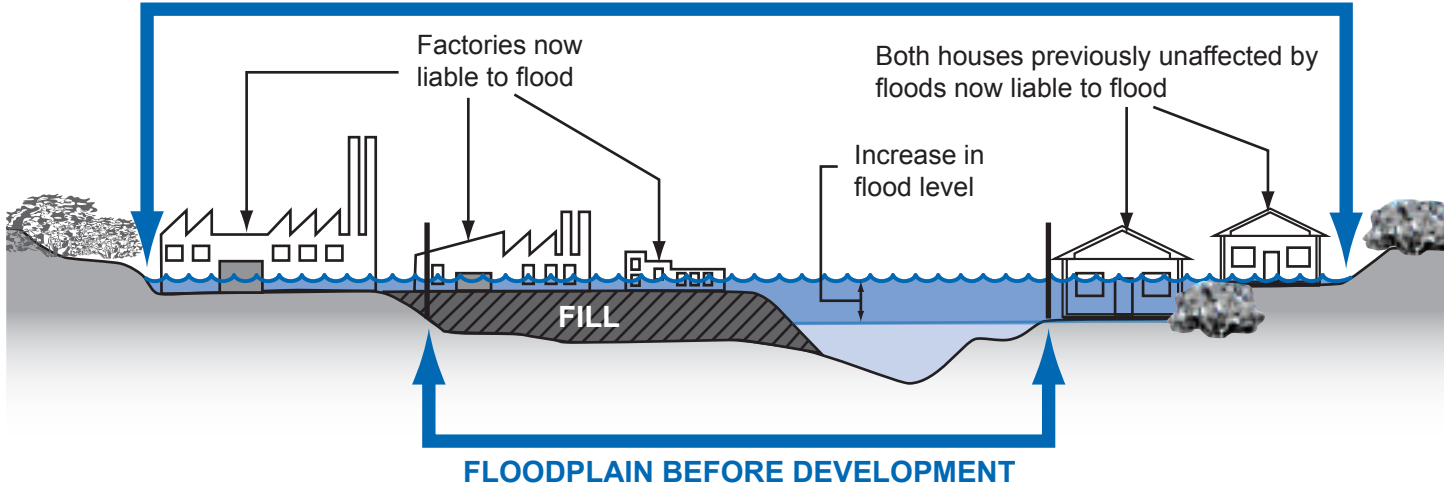

Today's Floodplain is not Tomorrow's Floodplain! Floodplain development, construction of roads across waterways, and development in the upper watershed can increase flood depths and alter flow patterns. Floodway fill may be allowed **only** if an engineering evaluation demonstrates that “no rise/no impact” in flood level will occur (see next page).

## Required Floodway "No Rise/No Impact" Certification

- Floodways can be dangerous because water may flow very fast.
- Development is not allowed unless there is "no rise" in flood elevations, floodway elevations, and floodway widths are certified.
- An engineer must evaluate the hydraulic impact of proposed development.
- A "no rise/no impact" certification is required and must be signed, sealed, and dated by a Professional Engineer licensed in West Virginia.
- Check with your community for guidance before you decide to work in a floodway.

### ENGINEERING "NO RISE/NO IMPACT" CERTIFICATION (excerpts)

This is to certify that I am a duly qualified engineer licensed to practice in the State of West Virginia.

It is to further certify that the attached technical data supports the fact that the proposed (Name of Development) will not impact the 100-year flood elevations, floodway elevations and floodway widths on (Name of Stream) at published sections in the Flood Insurance Study (FIS) for (Name of Community) (Dated) and will not impact the 100-year flood elevations, floodway elevations, and floodway widths at unpublished cross-sections in the vicinity of the proposed development.

\_\_\_\_\_  
(Date)

\_\_\_\_\_  
(Signature)

The engineering analysis must be based on technical data obtained from FEMA. **Reduce flood risk - don't build in the Floodway!**

## What is an Elevation Certificate and How is it Used?



- The Elevation Certificate (EC) is a FEMA form. Download a copy from <http://www.fema.gov/business/nfip/forms.shtm>.
- When the floodplain has BFEs, the EC must be completed and sealed by a surveyor or Professional Engineer licensed to practice in West Virginia.
- A community official may complete the EC or portions (Section G) for sites in approximate flood zones.
- The EC can be used to show that sites are located on natural ground above BFE (see page 43).
- The EC is used to verify that buildings are elevated properly (see page 44).
- Insurance agents use the EC to rate/write flood insurance policies.



### Important Information

**Remember**, when a new structure is built in the floodplain a **final construction** Elevation Certificate is required to satisfy Floodplain Ordinance requirements, obtain flood insurance and/or to obtain a LOMA.

By itself, the EC cannot be used to waive the requirements to get flood insurance. See pages 28 and 29 for information about Letters of Map Amendment (LOMA).

## Completing the Elevation Certificate

ELEVATION CERTIFICATE		(partial)																				
SECTION C - BUILDING ELEVATION INFORMATION (SURVEY REQUIRED)																						
C1. Building elevations are based on: <input type="checkbox"/> Construction Drawings* <input type="checkbox"/> Building Under Construction* <input checked="" type="checkbox"/> Finished Construction *A new Elevation Certificate will be required when construction of the building is complete.																						
C2. Elevations - Zones A1-30, AE, AH, A (with BFE), VE, V1-V30, V (with BFE), AR, AR/A, AR/AE, AR/A1-A30, AR/AH, AR/AO. Complete Items C2.a-h below according to the building diagram specified on Item A7. Use the same datum as the BFE. Benchmark Utilized <u>N/A</u> Vertical <u>NAVD 88</u> Conversion/Comments _____																						
a) Top of bottom floor (including basement, crawlspace, or enclosure floor) b) Top of the next higher floor c) Bottom of the lowest horizontal structural member (V Zones only) d) Attached garage (top of slab) e) Lowest elevation of machinery (Describe type of equipment in Comments) f) Lowest adjacent (finished) grade (LAG) g) Highest adjacent (finished) grade (HAG) h) Lowest adjacent grade at lowest elevation of deck or stairs, including structural support.	<table border="0"> <tr><td>_____</td><td><u>627.0</u></td><td><input checked="" type="checkbox"/> feet</td><td><input type="checkbox"/> meters (Puerto Rico only)</td></tr> <tr><td>_____</td><td><u>N/A</u></td><td><input type="checkbox"/> feet</td><td><input type="checkbox"/> meters (Puerto Rico only)</td></tr> <tr><td>_____</td><td><u>N/A</u></td><td><input type="checkbox"/> feet</td><td><input type="checkbox"/> meters</td></tr> <tr><td>_____</td><td><u>623</u></td><td><input checked="" type="checkbox"/> feet</td><td><input type="checkbox"/> meters</td></tr> <tr><td>_____</td><td><u>627.0</u></td><td><input checked="" type="checkbox"/> feet</td><td><input type="checkbox"/> meters</td></tr> </table>	_____	<u>627.0</u>	<input checked="" type="checkbox"/> feet	<input type="checkbox"/> meters (Puerto Rico only)	_____	<u>N/A</u>	<input type="checkbox"/> feet	<input type="checkbox"/> meters (Puerto Rico only)	_____	<u>N/A</u>	<input type="checkbox"/> feet	<input type="checkbox"/> meters	_____	<u>623</u>	<input checked="" type="checkbox"/> feet	<input type="checkbox"/> meters	_____	<u>627.0</u>	<input checked="" type="checkbox"/> feet	<input type="checkbox"/> meters	<p style="text-align: right;">ATTACHED GARAGE</p> <p style="text-align: right;">ELECTRICAL BOX WIRED FROM CEILING</p> <p style="text-align: right;">BFE 625</p> <p style="text-align: center;">FLOOD OPENING</p> <p style="text-align: center;">WATER HEATER ELEVATED ON PLATFORM</p> <p style="text-align: center;">COMPACTED FILL</p>
_____	<u>627.0</u>	<input checked="" type="checkbox"/> feet	<input type="checkbox"/> meters (Puerto Rico only)																			
_____	<u>N/A</u>	<input type="checkbox"/> feet	<input type="checkbox"/> meters (Puerto Rico only)																			
_____	<u>N/A</u>	<input type="checkbox"/> feet	<input type="checkbox"/> meters																			
_____	<u>623</u>	<input checked="" type="checkbox"/> feet	<input type="checkbox"/> meters																			
_____	<u>627.0</u>	<input checked="" type="checkbox"/> feet	<input type="checkbox"/> meters																			

In this example, the BFE is 625.

The slab-on-grade house was elevated on fill 2' above the BFE, and the attached garage is 2' below BFE.

You must have a surveyor or Professional Engineer licensed to practice in West Virginia, complete the Elevation Certificate and seal it. The Elevation Certificate includes diagrams for ten building types. Several points must be surveyed.



## Is Your Building Site Higher than the BFE?

If your land is shown on the maps as “in” the SFHA but the Lowest Adjacent Grade of your building site is higher than the BFE, FEMA may issue a LOMA that can be used to exempt you from the mandatory flood insurance purchase requirement. See pages 28 and 29 for information on the application requirements for different types of LOMAs.

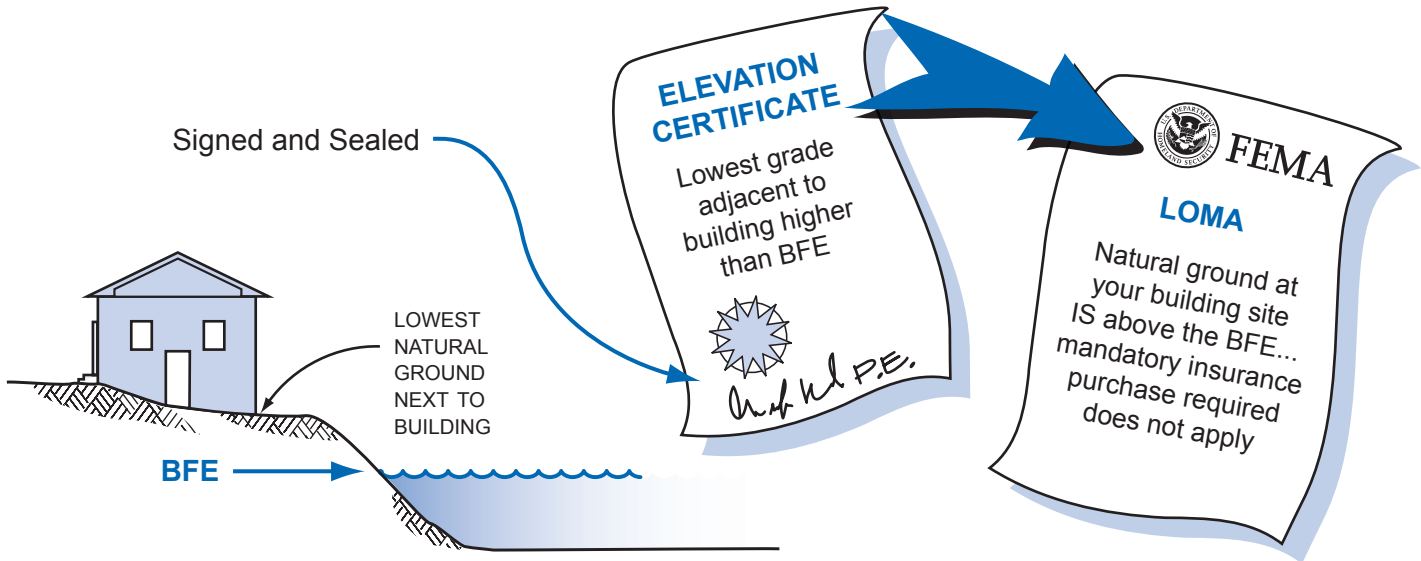

Getting a LOMA is the **only** way to remove the requirement to purchase flood insurance. Keep the Elevation Certificate (if applicable) and the LOMA with your deed, it will help future buyers.



### Terms and Definitions

**Lowest Floor** - the lowest floor of the lowest enclosed area (including basement). An unfinished or flood resistant enclosure, usable solely for parking of vehicles, building access or storage in an area other than a basement area is not considered a building's lowest floor; provided that such enclosure is not built so as to render the structure in violation of the applicable non-elevation design requirements.

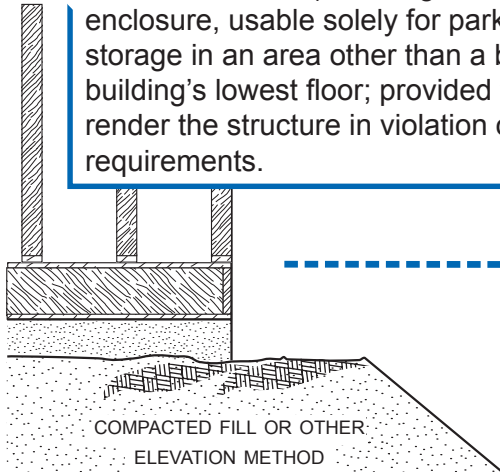

**ELEVATION  
CERTIFICATE**

Compliant  
Lowest Floor at  
or above BFE



*W. H. P. E.*

The lowest floor of a building and its relationship to the BFE is used to determine flood insurance rates. The lowest adjacent grade and its relationship to the BFE is used to determine if flood insurance is mandatory (previous page). If the lowest floor of a structure is at or above the BFE, a completed Elevation Certificate can be used to get lower cost flood insurance (see page 69). Two feet above BFE is recommended and is required in most communities.

## How to Elevate Your Floodplain Structure

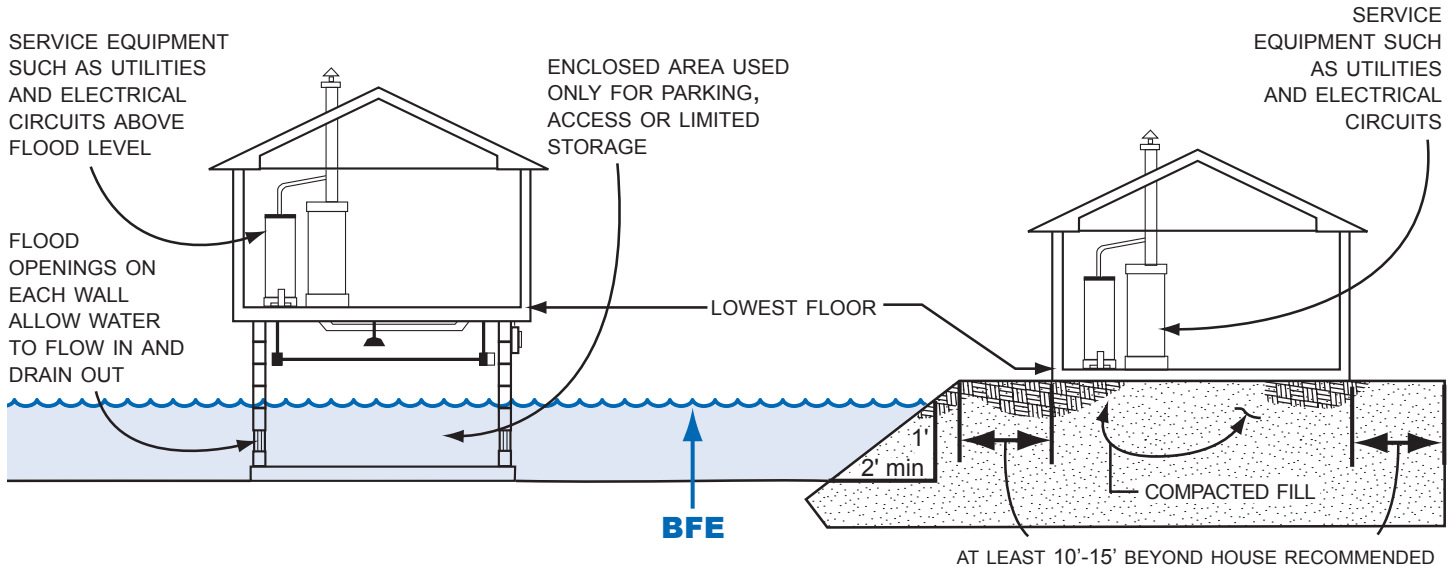

**Caution!** Enclosures (including crawlspaces) must meet special design requirements (see pages 49 and 50). **Note:** When the walking surface of the lowest floor is at the minimum elevation, under floor utilities are not allowed.

## Elevating an Existing Structure

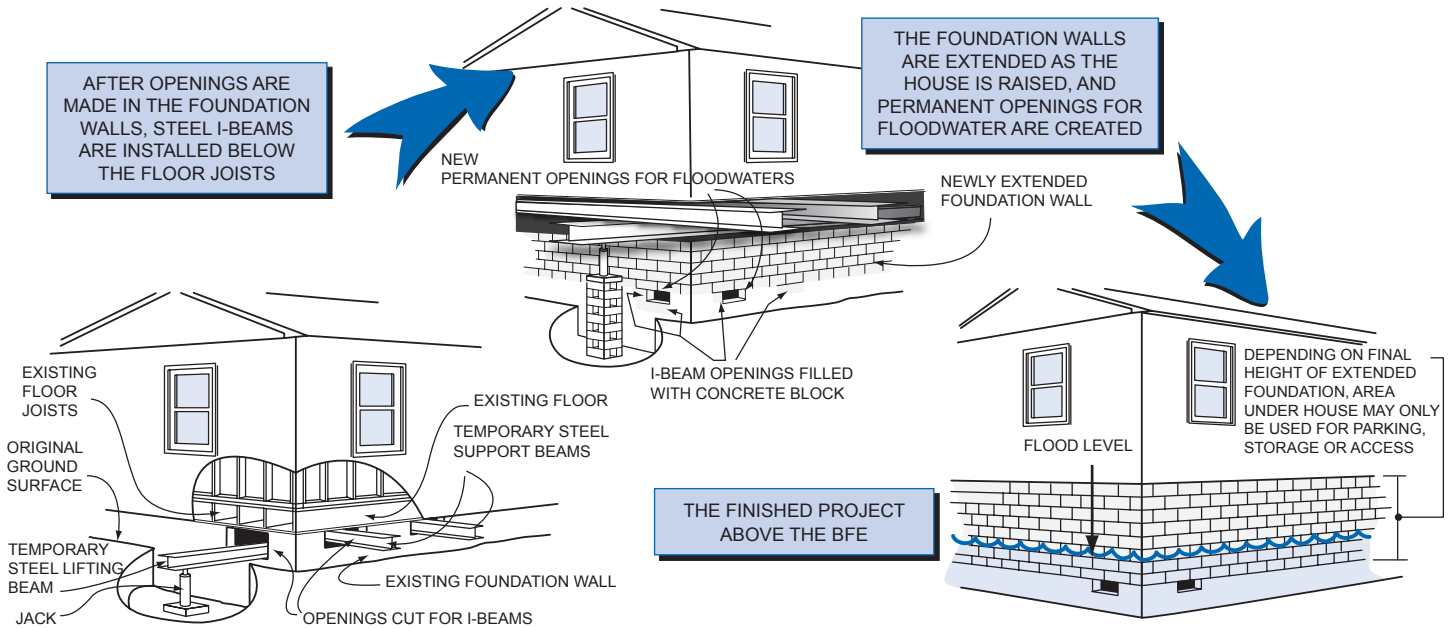

This is one way to elevate an existing building to comply with floodplain regulations. See *Above the Flood: Elevating Your Floodprone House* (FEMA 347) for additional information. If your insured building is damaged by flood and your community determines it is substantially damaged, you may be eligible for an **Increased Cost of Compliance** payment (see page 67).

## Enclosures Below the Lowest Floor



**Important**

### Information

#### Note:

- Total net area of all total openings is 1 sq. in. per sq. ft. of enclosed area.
- A 30' x 50' building, 1500 sq. ft., needs 1,500 sq. inches of openings.
- Standard ventilation units used in foundation walls must be disabled in the open position to allow water to flow in and out.
- A standard ventilation unit with screen, provides 42 to 65 sq. inches of opening.

**Alternative:** Engineered openings are acceptable if certified to allow adequate automatic inflow and outflow of floodwaters.

Solid perimeter walls can enclose floodprone areas. A crawlspace is a good way to elevate a few feet. In all cases the following are required: flood openings, utilities elevated to or above the BFE, two feet above BFE is recommended and is required in most communities, flood resistant materials and limitations on use of enclosures below the lowest floor. Check with the local permit office for details and restrictions.

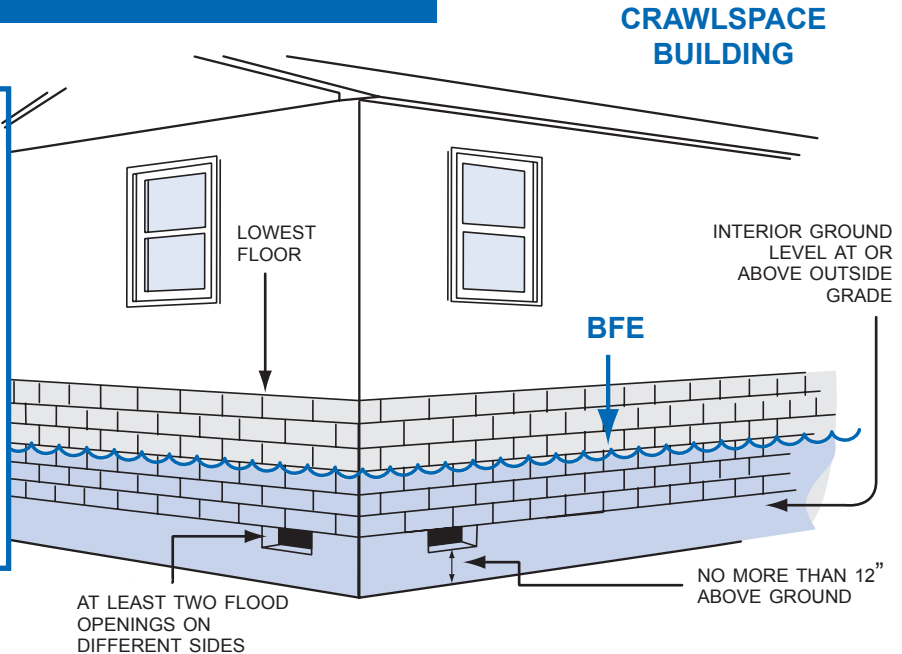

## Crawlspace Details

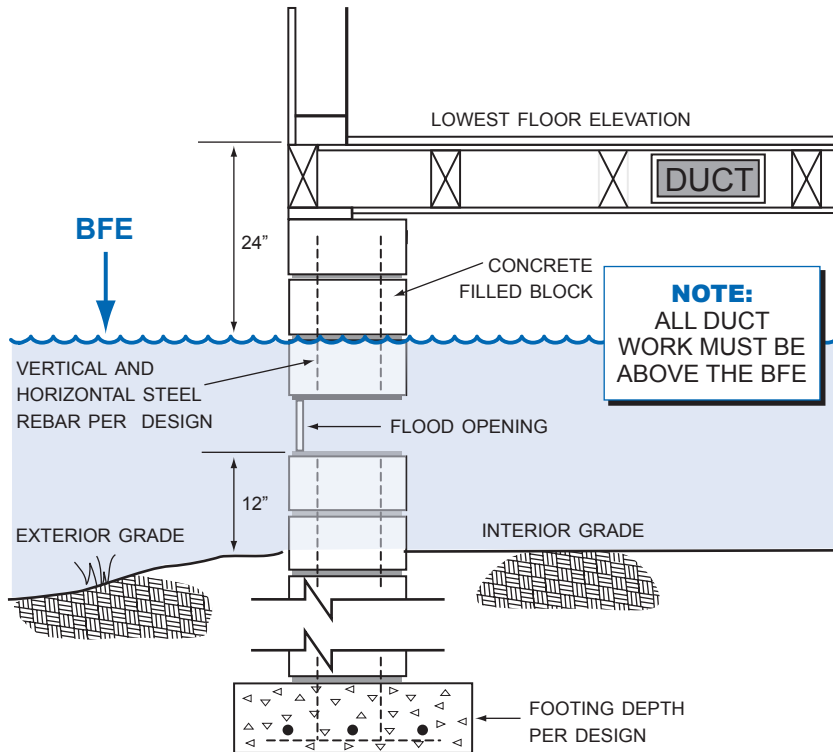

- The Lowest Floor Elevation must be at or above the BFE. Two feet above BFE is recommended and is required in most communities.
- The bottom of flood openings must be no more than 1 foot above the grade.
- Standard ventilation units must be permanently disabled in the “open” position to allow water to flow in and out.
- Interior and exterior grades must be equal on at least one side of the structure.

### Calculate Net Flood Opening:

A building that measures 30' x 50' has 1,500 square feet of enclosed crawlspace. Flood vents must provide 1,500 sq. in. of net open area (or have certified engineered openings). If a standard air vent unit provides 60 sq. in. of net open area, then to satisfy the flood opening requirement 25 vents are required (1,500 divided by 60).

## Utility Service / Fuel Tanks

All utilities, appliances, and equipment must be elevated to or above the BFE. Utilities include plumbing, ducts, electrical, gas lines, fuel tanks, and heating, ventilating and air conditioning equipment.

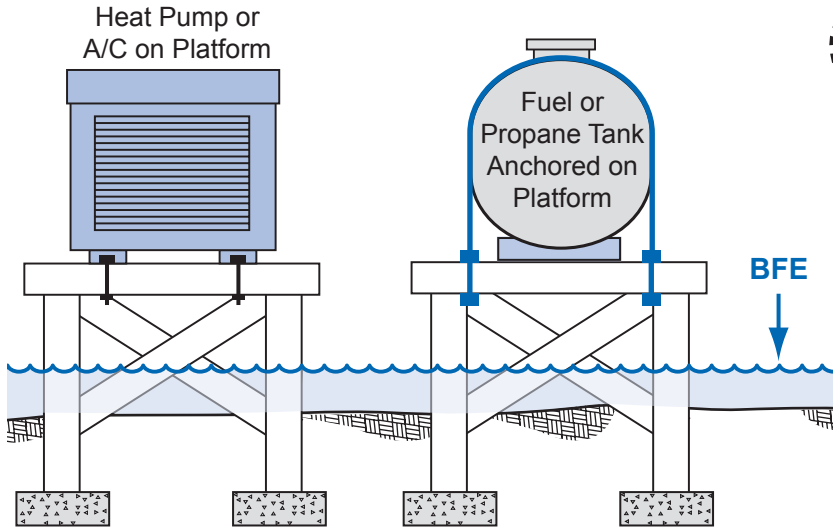

**Important**

### Information

For floodplain management purposes, a gas or a liquid storage tank that is principally above ground is considered a structure and must be elevated to or above the BFE. Two feet above BFE is recommended and is required in most communities.

Fuel and propane tanks can pose serious threats to people, property, and the environment during floods. Even shallow water can create significant buoyant forces on tanks so extra care must be taken to ensure that all tanks are appropriately anchored.

Videos on “Fuel Tank Flood Hazards” and “How to Anchor Home Fuel Tanks” are available from FEMA Publications at 1-800-480-2520 and “How-To Guides” on anchoring fuel tanks and other flood damage reduction techniques are available at: <http://www.fema.gov/library/viewRecord.do?id=3262>. Verified

## Utility Service Inside Enclosures

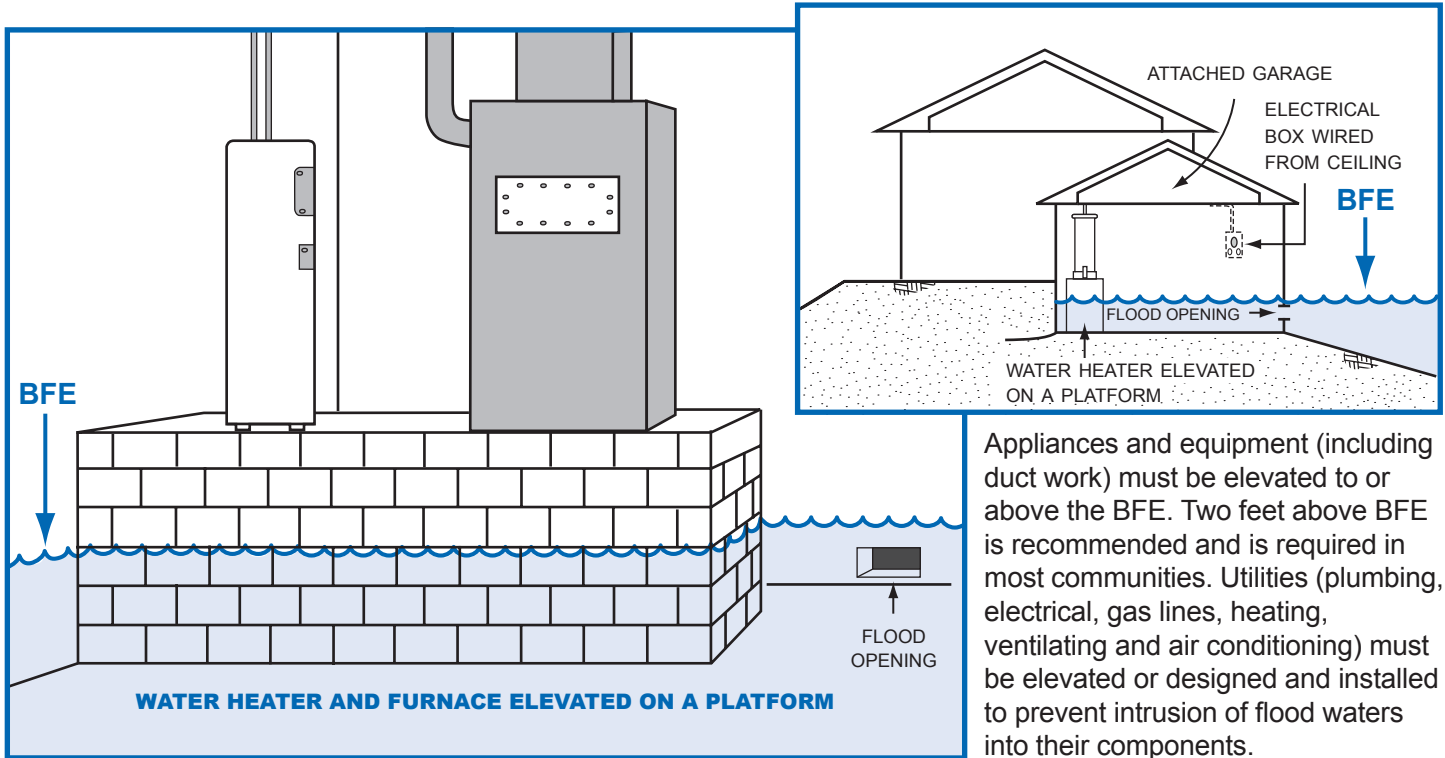



## Low Cost Flood Protection for Older Homes

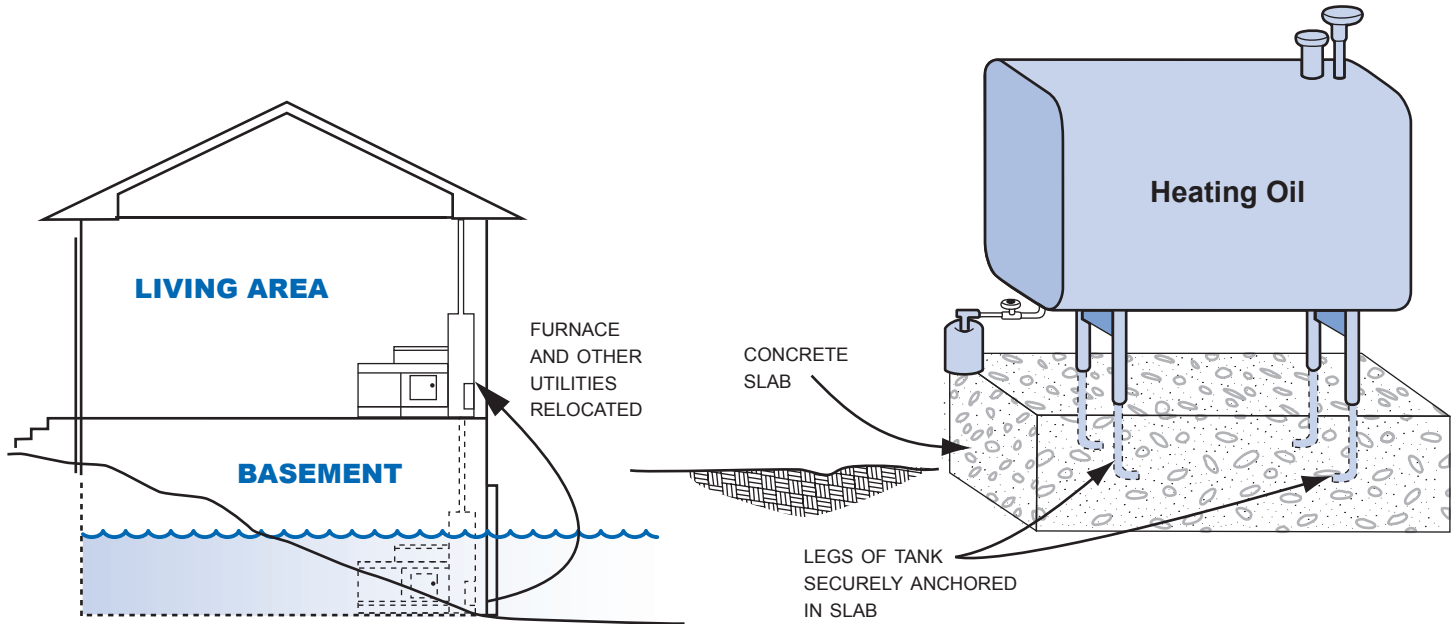

Move your water heater and furnace out of the basement, or build small elevated platforms for them. If the flood depth is less than two feet, build flood walls or anchor the tanks. **Do not** store valuables in a floodprone basement. Use flood resistant materials when you repair.

## Berms/Floodwalls Can Protect Pre-FIRM (older) Structures

In areas where flood waters are not expected to be deep, sometimes individual buildings can be protected by earthen berms or concrete floodwalls. Permits are required for those protection measures, and extra care must be taken if the site is in a floodway (see pages 41 and 42). A berm or floodwall does not remove building elevation requirements and cannot be used to protect a new and substantially improved structure, or one that is repaired after substantial damage.

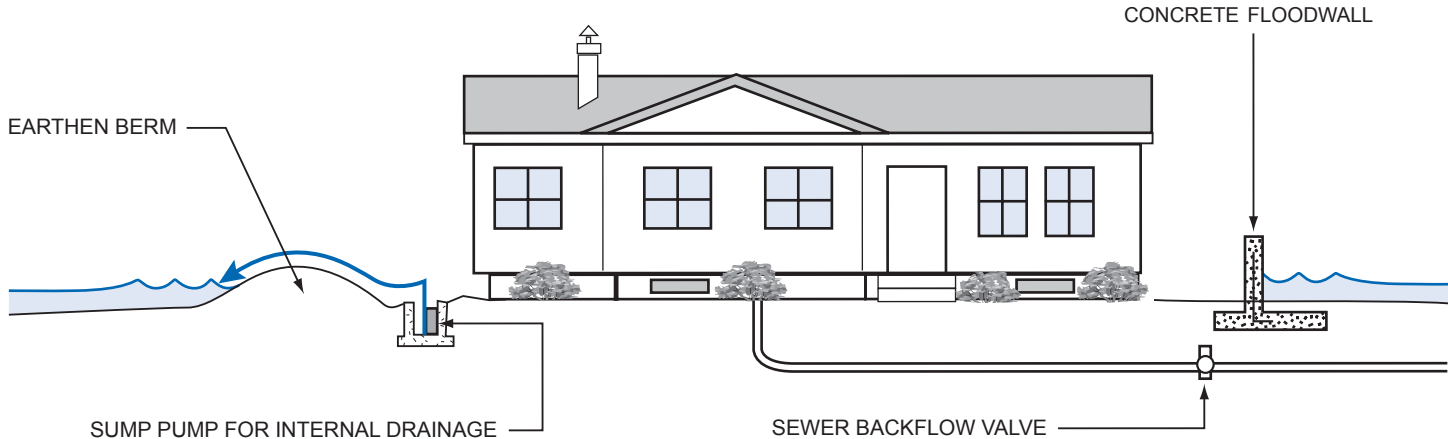

**Important!** These protective measures **will not** reduce your flood insurance premiums!

## Manufactured Homes Deserve Special Attention

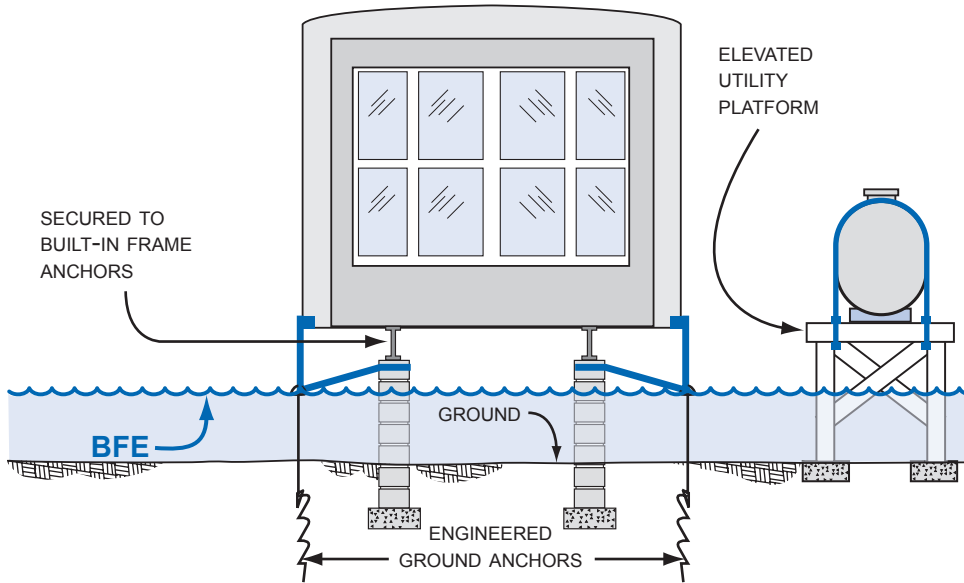

Experience shows that manufactured homes are easily damaged. As little as one foot of water can cause substantial damage.

Dry stacked blocks are not acceptable. They will **not** withstand a flood.

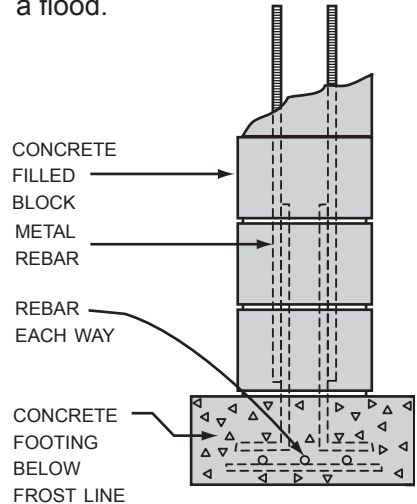

Manufactured homes must be anchored to resist flotation, collapse and lateral movement by being tied down in accordance with your community's floodplain ordinance.

## Installation of Manufactured Homes

In West Virginia, for new or used manufactured homes purchased from a licensed West Virginia dealer or installed by a licensed West Virginia installer, manufactured homes can only be installed using one of three approaches.

- 1** The installation manual appropriate to the manufactured housing unit **but only** if the installation method specifically states it is for use in a flood hazard area.
- 2** An installation design engineered for use in a flood hazard area and approved for site specific flooding conditions (preferred method).

Consistent with the requirements of National Fire Protection Association (NFPA) 225:

Model Manufactured Home Installation Standard effective 2017.

The referenced NFPA standard mirrors the minimum requirements local governments must adopt to participate in the National Flood Insurance Program. However, the NFPA standard also includes a requirement that the installer “assure that the home installation conforms to applicable federal, state, and **local** codes and regulations”. Thus if a local floodplain ordinance is more stringent than the minimum requirements for participation in the National Flood Insurance Program the installer **must** comply with the more stringent requirements.

Installers and owners must agree on an installation option as part of the contract for installation. The licensed installer or dealer must perform a site review to assure the installation approach is compatible with the site conditions, **including flood hazard areas**.

For more information on the installation of manufactured homes in regulatory flood hazard areas contact the West Virginia State Floodplain Management Coordinator at [Kevin L. Sneed@wv.gov](mailto:Kevin.L.Sneed@wv.gov). For detailed information see FEMA publication *Manufactured Home Installation in Flood Hazard Areas* (FEMA-85). To file a complaint concerning incorrect installation contact the West Virginia Division of Labor at 304-558-7890.

## Recreational Vehicles

### In a Special Flood Hazard Area, a Recreational Vehicle (RV) must:

- Remain on site for fewer than 180 consecutive days, **or**
- Be fully licensed and ready for highway use; **or**
- Meet the permitting, elevation, and anchoring requirements for manufactured homes of the community's Flood Damage Prevention Ordinance.

A recreational vehicle is ready for highway use if it is on its wheels or jacking system, is attached to the site only by quick-disconnect type utilities and security devices, and has no permanently attached additions.

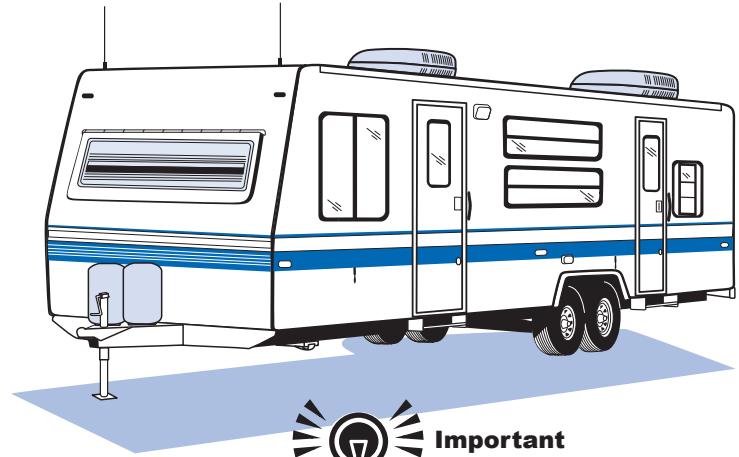

**Important**

### Information

Camping near the water? Ask the campground or RV Park operator about flood warnings and plans for safe evacuations.

RVs that do not meet these conditions must be installed and elevated like a manufactured home, including a permanent foundation and tie-down (See pages 55 and 56).

### Accessory Structures in a Special Flood Hazard Area:

- Cannot be modified for a different use in the future.
- Must be used only for parking or storage.
- Must have flood openings.
- Must be built of flood resistant materials.
- Must have elevated utilities.
- Must be anchored to resist floating.
- Must not be inhabited.
- Must have a documented floor elevation.

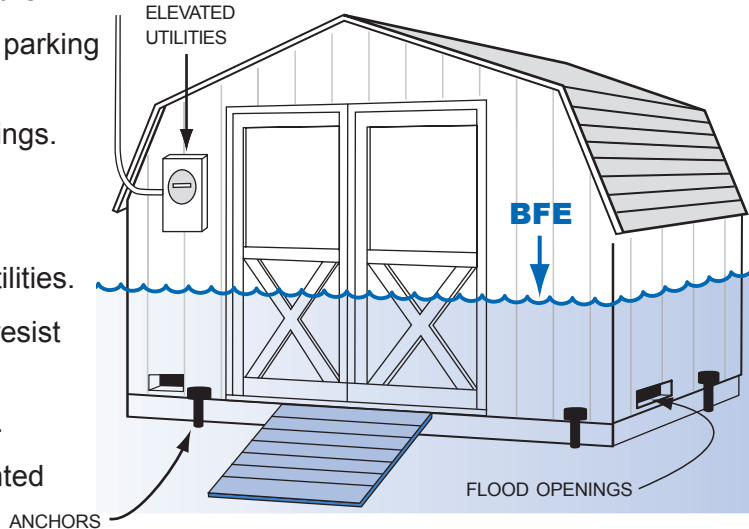

## Terms and Definitions

### Accessory (Appurtenant) Structure

means a structure that is located on the same parcel of land as a principle structure and whose use is incidental to the use of the principal structure. Accessory structures should be no more than a minimal initial investment, may not be used for human habitation, and must be designed to minimize flood damage. Examples include: detached garages, carports, storage sheds, pole barns, and hay sheds.

Even small buildings are considered “development” and permits or variances with noted conditions, are required. **Caution!** Remember...everything inside is likely to get wet when flooding occurs.

## Private Water Crossings

Private stream crossings, including bridges, low water crossings and culverts can be vulnerable to flood damage if not designed and constructed to perform safely under varying natural conditions. Poorly designed and constructed stream crossings can result in extensive property damage, danger to people and environmental damage. To minimize or eliminate losses, stream crossings should be sited and built using the following general criteria.

- Fairly level with long approaches with gentle slopes and firm, stable soil conditions.
- Relatively shallow water depth and low velocity during floods.
- Minimum probability of scouring and sediment displacement.
- Adequate spacing for entering the public highway at right angles.
- Away from fish spawning areas, water intakes and lake outlet sites.
- The flood carrying capacity of the existing channel must be maintained.

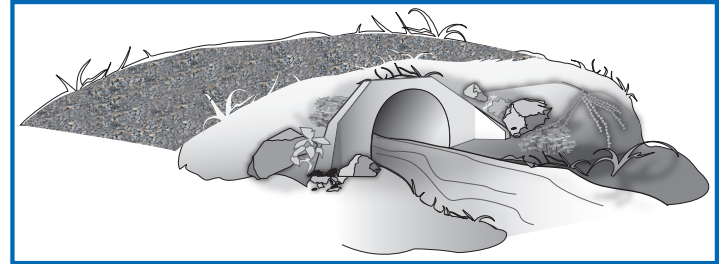

Structural design must be based on the maximum anticipated water depth and velocity and the intended use of the crossing. Coordination between the owner, engineer, contractor and appropriate local, state and federal agencies is essential to project success. Remember permits from multiple government agencies are required.

The FEMA Region III publication, *Private Water Crossings: Considerations before you build or rebuild* does not provide individual engineering and construction designs, it does include information and examples useful in deciding which type of crossing may best fit particular situations. It is available online at [http://www.wvdhsem.gov/flplain\\_mgt1.htm](http://www.wvdhsem.gov/flplain_mgt1.htm).

## Planning to Improve Your Floodplain Building?

To obtain a permit to improve an existing building in the SFHA:

- You must provide a copy of your construction contract or a cost estimate (including estimated market value of your own or donated labor and materials). ■ Your community will compare the cost of the proposed work to the market value of your building. (Ref,pg 66)
- You may submit an independent assessment of the market value of the building, if performed by a qualified professional.
- If the cost of the improvement equals or exceeds 50% of the market value of the building, you must comply with the Substantial Improvement requirements in your ordinance.
- If the costs **do not trigger Substantial Improvement requirements**, then you should still consider ways to reduce future damage (see page 62).



### Terms and Definitions

Substantial Improvement means any reconstruction, rehabilitation, addition, or other improvement of a structure, the cost of which equals or exceeds 50% of the market value of the structure before the start of construction of the improvement. This term includes structures which have incurred Substantial Damage, regardless of the actual repair work performed (see pages 65 and 66).



### Important

### Information

Improvements include:

- Renovation/ rehabilitation of the interior of the existing building (see page 61).
- Lateral addition, without renovation or structural alteration of the existing building (see page 62).
- Lateral addition, with renovation or structural alteration of the existing building (see page 63).
- Vertical addition (add new story).



## Substantial Improvement: Renovation Only

Two feet above BFE is recommended and is required in most communities.

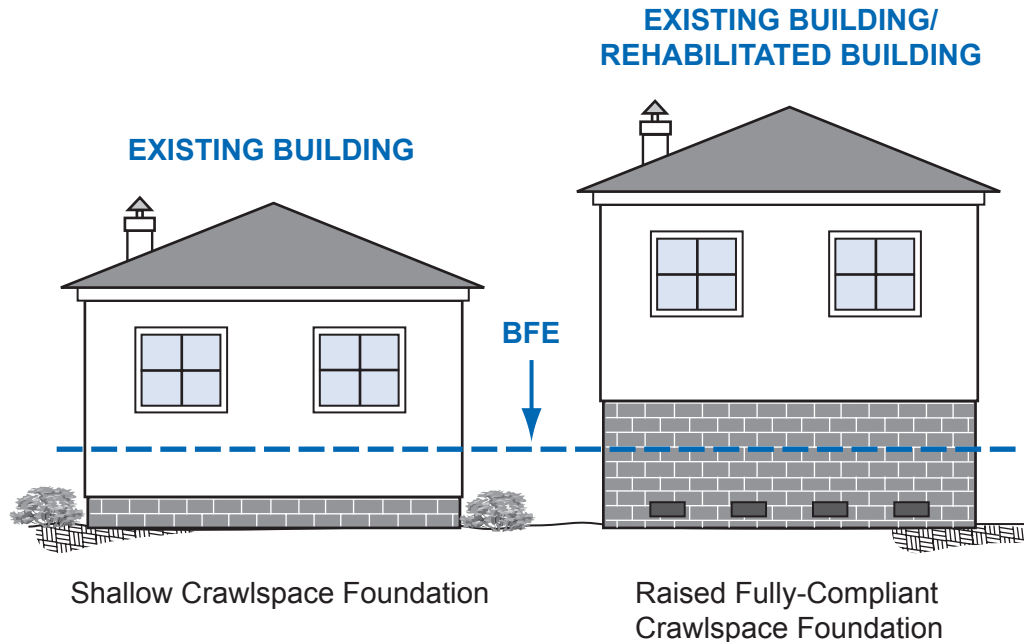

**Important**

### Information

Floodplain buildings can be improved, renovated, rehabilitated or altered, but special rules apply.

Check with your local permit office before you begin. It will be easier to do it right the first time.

The cost to correct previously cited violations of state or local health, sanitary, or safety codes to provide safe living conditions can be excluded from the cost of renovations.

Alteration of a registered historic structure is allowed, as long as it will continue to meet the criteria for listing as a historic structure.

## Substantial Improvement: Lateral Addition Only

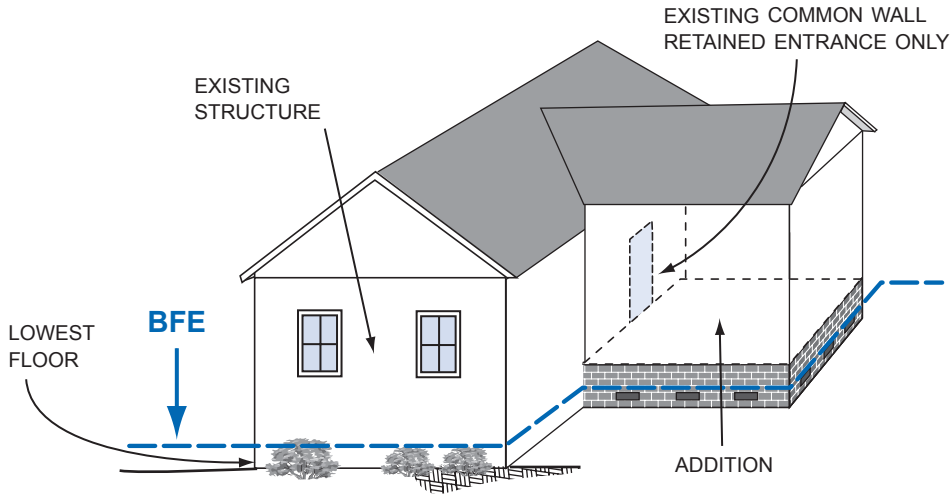

### Important

### Information

See next page if your project to add a lateral addition also includes modifying the interior of the existing building or making structural modifications to the existing common wall.

You must get a permit from your community to build an addition to your floodplain building. If the existing building is not already properly elevated, then only the addition must be built with the lowest floor at or above the Base Flood Elevation, two feet above BFE is recommended and is required in most communities, provided:

- You make no interior modifications to the existing building; and,
- You make no structural modifications to the existing common wall other than adding a connecting doorway.

## Substantial Improvement: Addition Plus Other Work

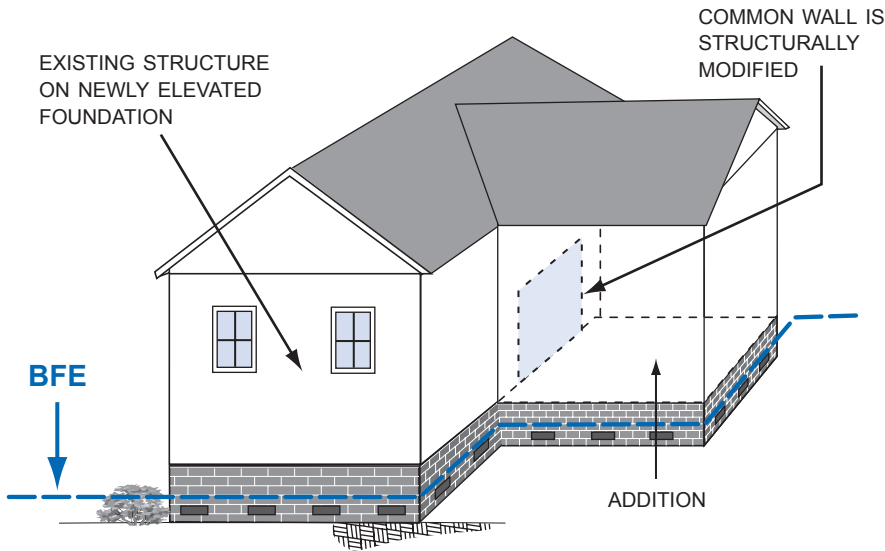

Two feet above BFE is recommended and is required in most communities.

Your community's permit office can help you determine which requirements apply. It is always a good idea to request a preliminary review before you get too far along with your plans.

Your community must prepare an evaluation to determine if all of your proposed work will trigger the Substantial Improvement requirement. Substantial Improvement is triggered if:

- The work involves adding a new top floor, modifying the interior of the existing building, or structural modifications to the existing common wall (for lateral addition); and,
- The cost of all proposed work equals or exceeds 50% of the market value of the existing building.

## Non-Substantial Improvements

Your proposed improvements are "non-substantial" if the cost of improvements are less than 50% of the market value of the building. Although you are not required to bring the existing building into compliance, there are many things you can do to reduce future flood damage. Find out the BFE at your location and consider the following:

- Use flood resistant materials, for example tile, closed-cell wall insulation, and polyvinyl wall coverings.
- Raise air conditioning equipment, heat pump, furnace, hot water heater, and other appliances on platforms.
- Install electrical outlets higher above the floor.
- Move ductwork out of crawlspaces.
- Retrofit crawlspaces with flood openings.
- Fill in below-grade crawlspaces/utility space.



**Note!** Be sure to include **all** proposed work in your initial permit application. If you add more work after the permit is issued, your community will make another evaluation for Substantial Improvement. Though you may not be required to elevate your structure elevating it to or above the BFE or more will bring significant flood insurance savings. See page 69 for more information.

## What About After Damage?

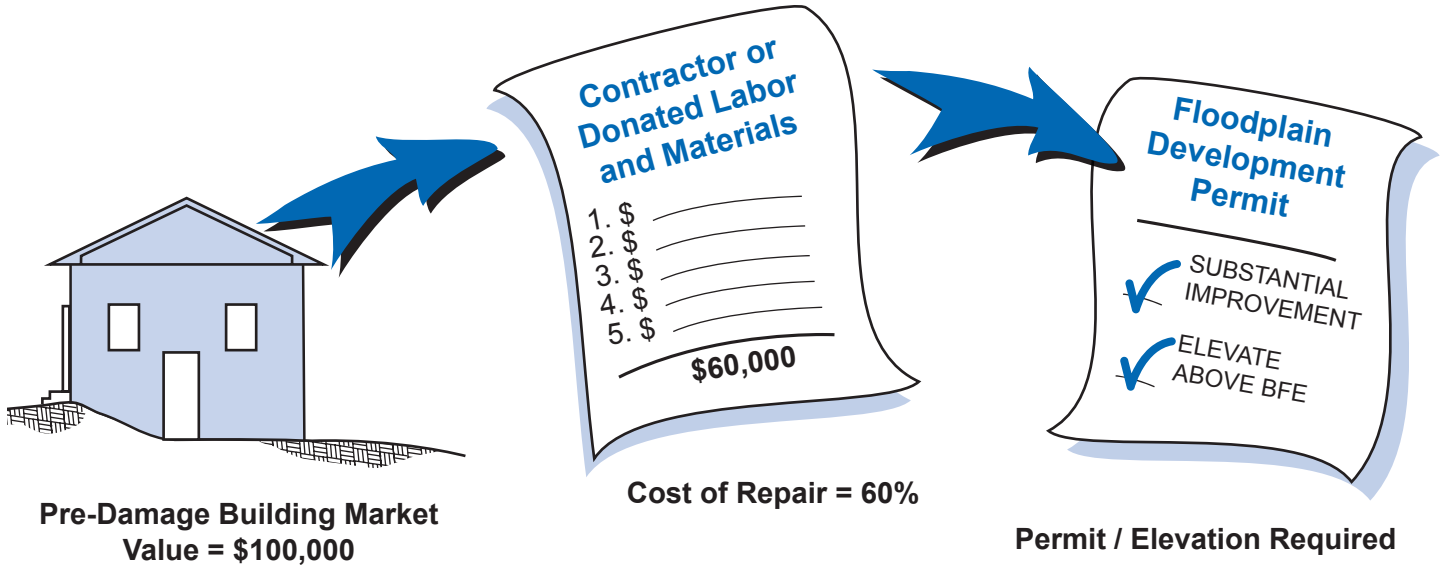

A permit is required to repair substantial damage from any cause - fire, flood, wind, or even a truck running into a building. Check with your permit office to be sure. You will be asked to provide a detailed cost estimate for repairs. The value of donated labor and materials, estimated at current market value, is considered as a cost of the repair.

## Substantial Damage/Improvement Calculations

A building in a Special Flood Hazard Area is substantially damaged/improved if the total cost of the repair/renovation is equal to or exceeds 50% of the building's pre-damage/improved market value.

Building Market Value may be determined using various methods. Only the value of the building itself must be determined. The value of contents and other site improvements such as landscaping, pavement, pools and detached buildings are not included. Methods include:

- Independent appraisals by professional appraiser.
- Tax Assessor Report (adjusted assessed value if appropriate).
- Qualified estimates based on sound professional judgment made by a staff of the local building department or local tax assessor's office.
- Other described and documented methods.

Divide the cost of the repair/renovation by the Building Market Value to determine the percentage of the damage/improvement. For example:

- Cost of repair/renovation is \$60,000 and Building Market Value is \$100,000.
- $\$60,000/\$100,000 = .6 \times 100 = 60\%$ . The building must be elevated to or above the BFE or to the additional freeboard requirements of the local ordinance (two feet above BFE in most communities).

A Substantial Damage/Improvement Calculation form is available from the West Virginia State Floodplain Management Coordinator at [Kevin L. Sneed@wv.gov](mailto:Kevin.L.Sneed@wv.gov). For additional guidance see Part 3 of the FEMA publication "*Answers to Questions About Substantially Damaged Buildings*" (FEMA-213).

## Paying for Post Flood Compliance - ICC



Increased Cost of Compliance, or ICC, coverage is part of most Standard Flood Insurance Policies. Claims for ICC benefits are filed separately from your claim for contents or building loss. If eligible, you can collect up to \$30,000 to help cover the cost of bringing your home or business into compliance with current flood damage prevention ordinances.

You are eligible to file for ICC if your property is in a SFHA and if your community Floodplain Administrator determines one of the following:



Your property is “substantially damaged” by flooding. This means that your community says the cost to repair your flooded building is 50 percent or more of its pre-disaster market value.

Your property sustained “repetitive damage.” This term applies to homes or businesses that were damaged by flooding twice in the past 10 years, where the cost of repairing the flood damage, on average, equaled or exceeded 25 percent of the property market value at the time of each flood. Also, there must have been flood insurance claim payments for each of the two flood losses, **and the community’s flood damage prevention ordinance must have a repetitive loss provision.**



ICC funding can be used to elevate or demolish homes, relocate them to higher ground, or floodproofing of non-residential structures. Also, when participating in a community sponsored, FEMA funded mitigation project, the policyholder may assign ICC benefits to the community to integrate into the project. The community then becomes responsible for submitting all of the appropriate paperwork.

Detailed information on ICC is available at <http://www.fema.gov/plan/prevent/floodplain/ICC.shtm> and in the FEMA publication *Interim Guidance for State and Local Officials - Increased Cost of Compliance Coverage* (FEMA 301).

## Flood Insurance: Property Owner's Best Protection

Who needs flood insurance? Every homeowner, business owner, and renter in West Virginia communities that participate in the National Flood Insurance Program (NFIP) may purchase a flood insurance policy — regardless of the location of the building. Federal disaster grants may not cover all losses and repayment of a disaster loan can cost many times more than what you'll pay for a flood insurance policy.

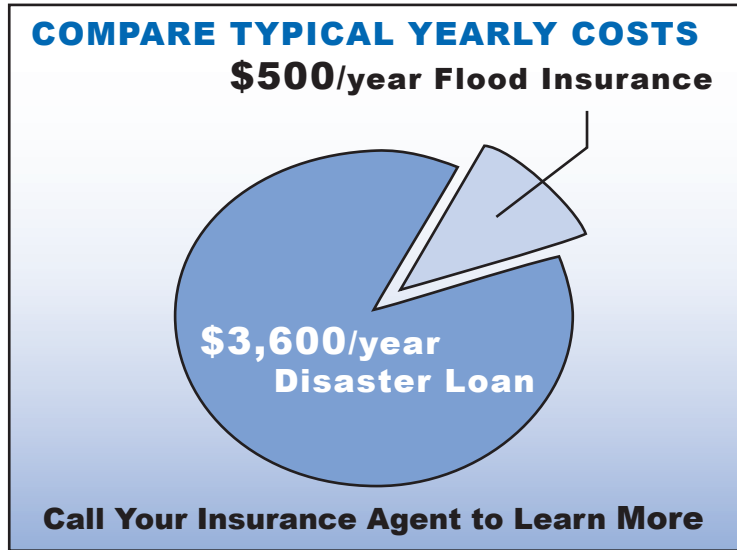

Unfortunately, it's often after a flood that many people discover that their homeowner or business property insurance policies do not cover flood damages. Approximately 25% of all flood damages occur in low risk zones, commonly described as being "outside the mapped flood zone."

The West Virginia Department of Homeland Security Emergency Management and the West Virginia Insurance Commissioner urge you to protect your financial future by getting a flood insurance policy. To purchase a policy, call your insurance agent. To get the name of an agent in your community, call the NFIP's toll free number **888-356-6329**.



## Freeboard: Go Above the BFE

Want to save some money and have peace of mind at the same time? Then add Freeboard to build higher than the minimum elevation requirement! In West Virginia new construction and substantially improved structures must be built to or above the BFE (two feet above BFE recommended and in many communities required). Additional Freeboard will add safety and reduce flood insurance costs.

### Annual Flood Insurance Premium\* Example

Flood Zone A-AE, Post-FIRM, One-Story Single-Family Residence, No Basement  
Lowest floor elevation compared to the Base Flood Elevation (BFE)

Lowest Floor Elevation	Structure \$150,000	Contents \$50,000	Federal Policy Fee	ICC Fee	Total Annual Premium	30-Yr. Mortgage Total Flood Insurance Cost
3' above	\$200	\$112	\$35	\$6	\$353	\$10,590
<b>2' above</b>	<b>\$275</b>	<b>\$112</b>	\$35	\$6	<b>\$428</b>	<b>\$12,840</b>
1' above	\$450	\$140	\$35	\$6	\$631	\$18,930
At BFE	\$830	\$284	\$35	\$6	\$1155	\$34,650
<b>1' below</b>	<b>\$3280</b>	<b>\$973</b>	\$35	\$6	<b>\$4304</b>	<b>\$129,120</b>

\*October 1, 2008 Rate Tables

Though other factors affect flood insurance rates, the most significant is the relationship of the lowest floor elevation to the BFE. For Post-FIRM buildings (see page 71), **the lower the structure is relative to BFE the higher the cost of insurance.** This is true in all types of A Zones and for all insurable structures.



Important

### Information

**Note:** Building owners will save insurance money if they elevate above BFE. But more impressive is how the cost of insurance can almost quadruple if the building is even only one foot below BFE.

### Remember!

A community may be able to grant a variance, but the owner will probably still be required to buy flood insurance. Imagine trying to sell a house if the bank requires insurance that costs over \$4,300 a year!

## Flood Insurance in Approximate A Zones

The flood elevation data generated to build a structure “reasonably safe from flooding” in the Approximate A Zones can have a significant impact on your flood insurance premium.

- 1** If a community just requires a structure to be elevated 3 feet above the Highest Adjacent Grade (HAG), flood insurance is rated using only this elevation information and will be in the highest rate category. Going two feet higher (5 foot above HAG) can significantly reduce premiums. Caution, when the crawlspace or “walkout garage” level of the structure does not have appropriate and sufficient flood openings that level will become the lowest floor for rating purposes, if structure is built into a slope the crawlspace/walkout level will be below the HAG (negatively rated) resulting in extremely costly flood insurance premiums.
- 2** If a community establishes a “Community Flood Elevation” using a semi-detailed method and lists the elevation in Section G of the Elevation Certificate the structure can be rated by how high the “lowest floor” is above the “Community Flood Elevation”. This rating method should result in significantly better rating than the floor 3 foot above Highest Adjacent Grade method. If the structure is built two feet above the Community Flood Elevation, the savings on the flood insurance premium in the first year will typically equal the cost of providing data for one of the semi-detailed methods. The flood insurance premium savings will continue in the following years.
- 3** If the developer hires an engineer and develops a BFE using HEC-RAS or similar Hydraulic and Hydrologic (H&H) engineering techniques the structure can be rated as if it were in a studied floodplain area, these rates are even lower than those resulting from the “Community Flood Elevation” method. and The flood insurance premium discount can be significant (see rates on preceding page). For high value structures the savings on flood insurance premiums can easily repay the cost of the H&H analysis within the first year or two. Same as in method 2 above, these even more significant flood insurance premium savings will continue in the following years.

## What is Meant by Pre-FIRM and Post-FIRM?

A building is Pre-FIRM if the "start of construction" was before December 31, 1974 or before the effective date of the community's initial FIRM, whichever is later. A building is Post-FIRM if the "start of construction" was on or after December 31, 1974 or the effective date of the initial FIRM, whichever is later.

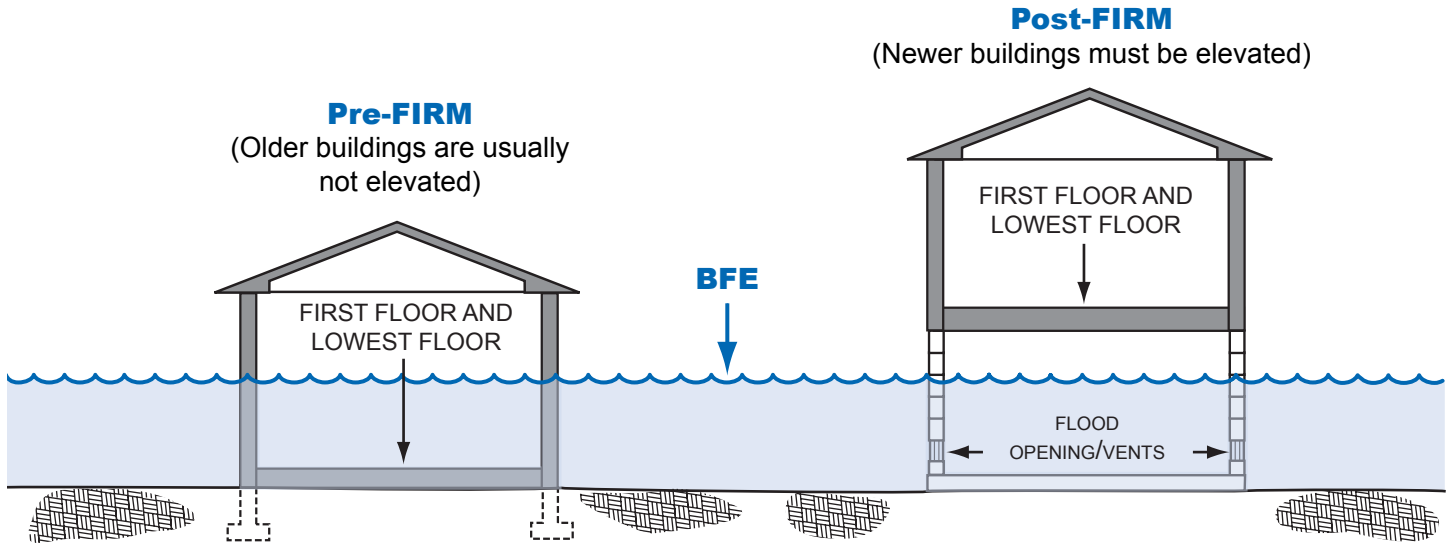

Pre-FIRM buildings can be insured using discounted rates. These rates are designed to help people afford flood insurance even though their buildings were not built with flood protection in mind. Insurance rates for Post-FIRM buildings are tied to the elevation of the lowest floor in relation to the BFE (see page 69).

## Want to Learn More?

- For information and advice on permits, call your community's building permit office or planning department.
- For advice on permitting and managing floodplains, contact the State Floodplain Management Program Coordinator at 304-957-2571.
- For information about workshops, training and conferences, contact the State Floodplain Management Program Coordinator at 304-957-2571.
- To order FEMA flood maps, call FEMA's Map Service Center at 800-358-9616 or order online at <http://www.msc.fema.gov/>.
- To check the status of map change requests, learn more about flood maps, map modernization, and other aspects of flood hazard mapping go to <http://www.fema.gov/plan/prevent/fhm/index.shtm>.
- FEMA's on-line publications can be found in the FEMA Virtual Library. Many are posted in the Portable Document Format (PDF). Go to <http://www.fema.gov/library/> for more information. You can order printed copies of FEMA publications from FEMA Publications at 800-480-2520.
- To learn about flood insurance, call your insurance agent. Most insurance companies can write an NFIP policy for you. Call the National Flood Insurance Program's toll free number, 888-356-6329, to get the name of an agent in your area who writes flood insurance.
- Online training in completing the Elevation Certificate is available at: <http://training.nfipstat.com/ecsurveyor/>.

## Floodplain Management Success Stories

West Virginia has many successes in floodplain management. As of August 2017, 278 communities in the state participate in the NFIP, including every community with an effective FEMA flood map. Many, many stories of successful implementation of NFIP requirements and beyond them can be told. Still we can continue to learn from the success of others.

Flooding is a national problem and throughout the United States many individuals, businesses and communities have been taking steps to combat its impacts. Many of these actions are documented. FEMA's Best Practice portfolio, available online at <http://www.fema.gov/plan/prevent/bestpractices/index.shtm>, is one good source for stories.

From the website you can search for stories by state, hazard, activity and other criteria. For instance a nationwide search for stories related to floodplain management returns over 35 stories on topics ranging from mitigating flood risk through buyout and elevation projects, to the connection between code and ordinance enforcement and reduced flood damage to the benefits of mitigation planning and participation in the CRS program. Also posted are stories documenting successful mitigation in West Virginia.

The Association of State Floodplain Managers website at <http://www.floods.org/> is also a good resource. Click on Publications and Policy Papers on the left then Publications. Among the resources available for download is the publication *Building Public Support for Floodplain Management*, which shows what can be done to build public support and how others have done it.

Have a story to tell? Contact the West Virginia State Floodplain Management Coordinator at [Kevin L. Sneed@wv.gov](mailto:Kevin.L.Sneed@wv.gov) to share it with others.

### Common Acronyms

BFE – Base Flood Elevation  
CLOMA – Conditional Letter of Map Amendment  
CLOMR – Conditional Letter of Map Revision  
CLOMR-F – Conditional Letter of Map Revision based on Fill  
CRS – Community Rating System  
DFIRM - Digital Flood Insurance Rate Map  
EC – Elevation Certificate  
FEMA – Federal Emergency Management Agency  
FBFM – Flood Boundary and Floodway Map  
FHBM – Flood Hazard Boundary Map  
FIRM – Flood Insurance Rate Map  
FIS – Flood Insurance Study  
ICC – Increased Cost of Compliance  
LOMA – Letter of Map Amendment  
LOMC – Letter of Map Change  
LOMR – Letter of Map Revision  
LOMR-F – Letter of Map Revision based on Fill  
NFIP – National Flood Insurance Program  
WVDHSEM – West Virginia Department of Homeland  
Security Emergency Management

### Internet Links

West Virginia Department of Homeland Security  
Emergency Management  
<http://www.wvdhsem.gov/>

West Virginia Conservation Agency  
<http://www.wvca.us/>

West Virginia Insurance Commission  
<http://www.wvinsurance.gov/>

Family Disaster Planning  
<http://www.redcross.org/>  
<http://www.fema.gov/areyouready/>

Repairing Your Flooded Home, ARC and FEMA  
<http://www.fema.gov/library/viewRecord.do?id=1418>

NFIP Floodplain Management Requirements  
A Study Guide and Desk Reference for Local Officials  
[http://www.fema.gov/plan/prevent/floodplain/fm\\_sg.shtm](http://www.fema.gov/plan/prevent/floodplain/fm_sg.shtm)

NFIP Publications  
<http://www.fema.gov/business/nfip/libfacts.shtm>

FEMA Elevation Certificate  
<http://www.fema.gov/business/nfip/forms.shtm>

NFIP Technical Bulletins  
<http://www.fema.gov/plan/prevent/floodplain/techbul.shtm>

## Selected Definitions

**Base Flood** – A term used in the FEMA National Flood Insurance Program (NFIP) to indicate the minimum size flood to be used by a community as a basis for its floodplain management regulations; presently required by regulation to be that flood which has a one-percent annual chance of being equaled or exceeded in any given year. Also known as a 100-Year Flood or One-Percent Annual Chance Flood.

**Base Flood Elevation (BFE)** – (1) The height in relation to mean sea level (MSL) expected to be reached by the waters of the Base Flood at specific points in the floodplain areas. (2) The elevation for which there is a one-percent chance in any given year that flood levels will equal or exceed it. (3) The elevation shown on the Flood Insurance Rate Map (FIRM) for Zones AE, AH, A1-A30, AR, AR/A, AR/AE, AR/A1-A30, AR/AH and AR/AO that indicates the water surface elevation resulting from a flood that has a one-percent or greater chance of being equaled or exceeded in any given year. The BFE is generally based on statistical analysis of stream flow records for the watershed and rainfall and runoff characteristics in the general region of the watershed, and application of hydraulic backwater models.

**Floodway or Regulatory Floodway** – means the channel of a river or other watercourse and the adjacent land areas that must be reserved in order to discharge the base flood without cumulatively increasing the water surface elevation more than one foot.

**Flood Insurance Rate Map (FIRM)** – The FIRM is the basis for floodplain management, mitigation, and insurance activities for the National Flood Insurance Program (NFIP). Insurance applications include enforcement of the mandatory purchase requirement of the Flood Disaster Protection Act which “...requires the purchase of flood insurance by property owners who are being assisted by Federal programs or by Federally supervised, regulated or insured agencies or institutions in the acquisition or improvement of land facilities

## Selected Definitions (continued)

located or to be located in identified areas having special flood hazards” (Section 2 (b) (4) of the 1973 Flood Disaster Protection Act). In addition to the identification of Special Flood Hazard Areas, the risk zones shown on the FIRMs are the basis for the establishment of premium rates for flood coverage offered through the NFIP.

**Freeboard** – Freeboard means a factor of safety usually expressed in feet above a flood level for purposes of floodplain management. “Freeboard” tends to compensate for the many unknown factors that could contribute to flood heights greater than the height calculated for a selected size flood and floodway conditions, such as wave action, bridge openings, and the hydrological effect of urbanization of the watershed.

**Reasonably Safe from Flooding** – Base flood waters will not inundate the land or damage structures to be removed from the SFHA and that any subsurface waters related to the base flood will not damage existing or proposed buildings.

**Special Flood Hazard Area (SFHA)** – is the portion of the floodplain subject to inundation by the base flood and/or flood related erosion hazards. SFHAs are shown on FHBMs or FIRMs as Zones A, AE, A1-30, AH, AO, and AR.

**Substantial Damage** – Damage of any origin sustained by a structure whereby the cost of restoring the structure to its “before damaged” condition would equal or exceed 50 percent of the market value of the structure before the damage occurred. All structures that are determined to be substantially damaged are automatically considered to be substantial improvements, regardless of the actual repair work performed. If the cost necessary to fully repair the structure to its “before damaged” condition is equal to or greater than 50% of the structure’s market value before damages, then the structure must be elevated (or floodproofed if it is non-residential) to or above the Base Flood Elevation (BFE), and meet other applicable NFIP requirements.



## Selected Definitions (continued)

**Substantial Improvement** – Any reconstruction, rehabilitation, addition, or other improvement of a structure, the cost of which equals or exceeds 50 percent of the market value of the structure before the “start of construction” of the improvement. This term includes structures which have incurred “substantial damage,” regardless of the actual repair work performed. The term does not, however, include either:

Any project for improvement of a structure to correct existing violations of state or local health, sanitary, or safety code specifications which have been identified by the local code enforcement official and which are the minimum necessary to assure safe living conditions or

Any alterations of a “historic structure,” provided that the alteration will not preclude the structure’s continued designation as a “historic structure.”

Floodplain management requirements for new construction apply to substantial improvements. NFIP Increased Cost of Compliance (ICC) coverage does not apply to substantial improvements unless a structure is substantially damaged due to flooding.

**Variance** – A grant of relief by a community from the terms of a floodplain management regulation. Because a variance can create an increased risk to life and property, variances from flood elevation or other requirements in the flood ordinance should be rare. Insurance premium rates are required by statute to be based on actuarial risk and will not be modified by the granting of a variance. Specific criteria for granting a variance is described in the supplemental information.

FEMA may review a community’s findings justifying the granting of variances, and if that review indicates a pattern inconsistent with the objectives of sound floodplain management, FEMA may take appropriate action including probation and suspending the community from the NFIP.

This *Quick Guide* may be downloaded from the  
West Virginia Department of Homeland Security Emergency Management website  
at: [http://www.dhsem.wv.gov/MitigationRecovery/Pages/Floodplain-  
Management.aspx](http://www.dhsem.wv.gov/MitigationRecovery/Pages/Floodplain-<br/>Management.aspx)